

Top 100
Global
Innovator
for 10 years

Linear Motor

Core Type Linear Motor
Coreless Type Linear Motor

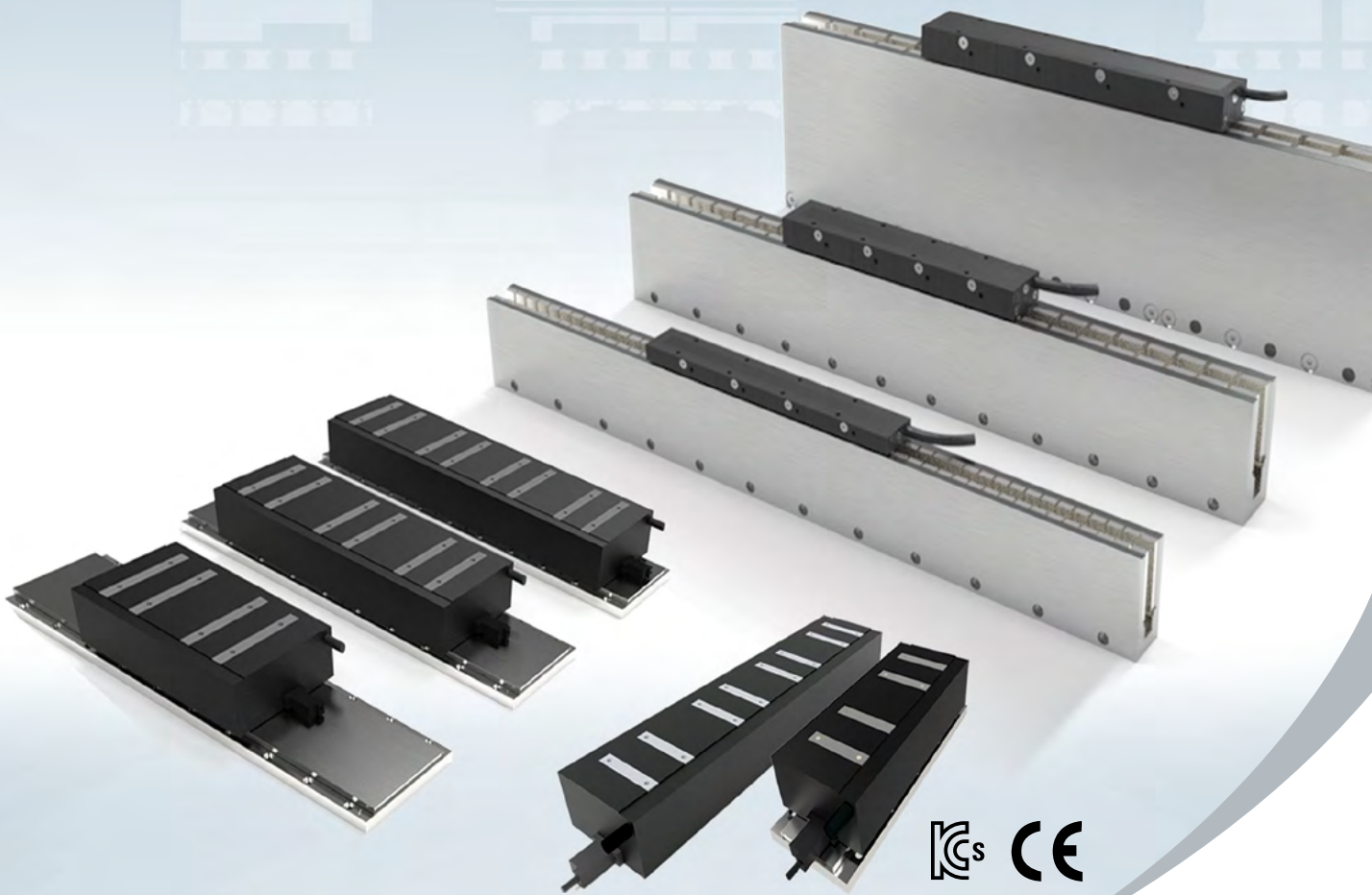

LS ELECTRIC

GEAMATIC
PRODOTTI PER L'AUTOMAZIONE INDUSTRIALE
www.geamatic.com

The right choice for fast and precise control!

Best fit your requirements: fast motor speed, precision control, powerful performance, compact size, etc.

Features of linear motors

High Speed 	Fast Acceleration / Deceleration 	No Friction 	No Length Restrictions 	Easy Maintenance 
--	--	---	--	--

Application

Display manufacturing & inspection / Semiconductor manufacturing & inspection / Automation system / Pick & Place
Medical applications / 3D printing / Mobile phone manufacturing & inspection, etc.

Linear Motor

Core Type Linear Motor / Coreless Type Linear Motor

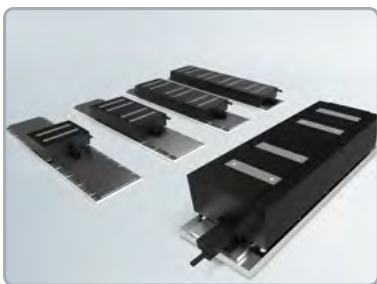

Why LS ?

Total Solution Provider

Different from most linear motor companies, LS provides total solution for the automation process.

Customization Service

For each customer, detailed and friendly consultations are possible.

High Quality

With high quality products and services, LS will evolve your factory to a fast and sophisticated one.

Reduced Noise Generation
Compared to General
Shaft drive Method



Efficient Function and
Operation are Possible

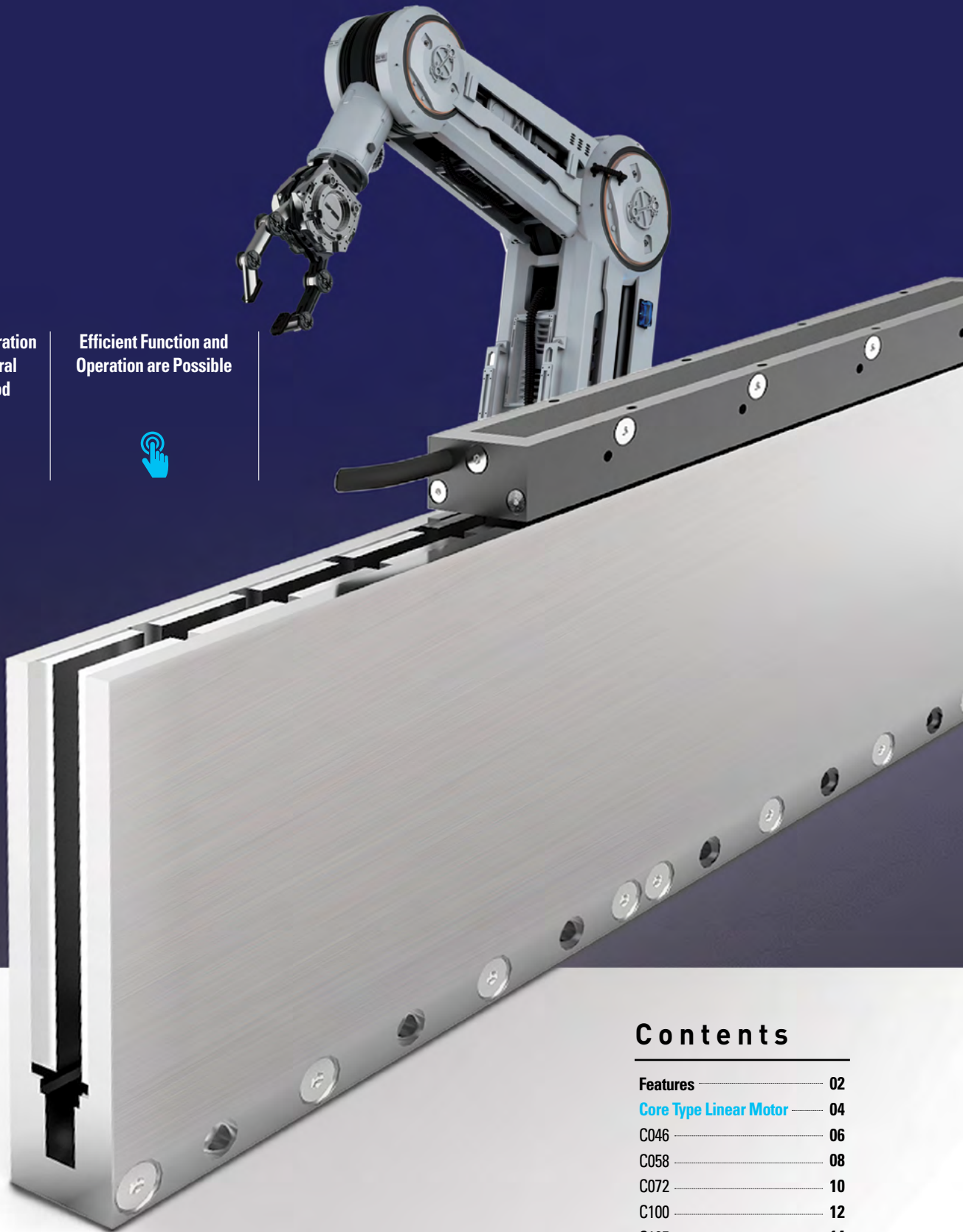

Contents

Features	02
Core Type Linear Motor	04
C046	06
C058	08
C072	10
C100	12
C165	14
Coreless Type Linear Motor	16
L076	18
L098	20
L132	22
L230	24
Xmotion Servo Drive	26

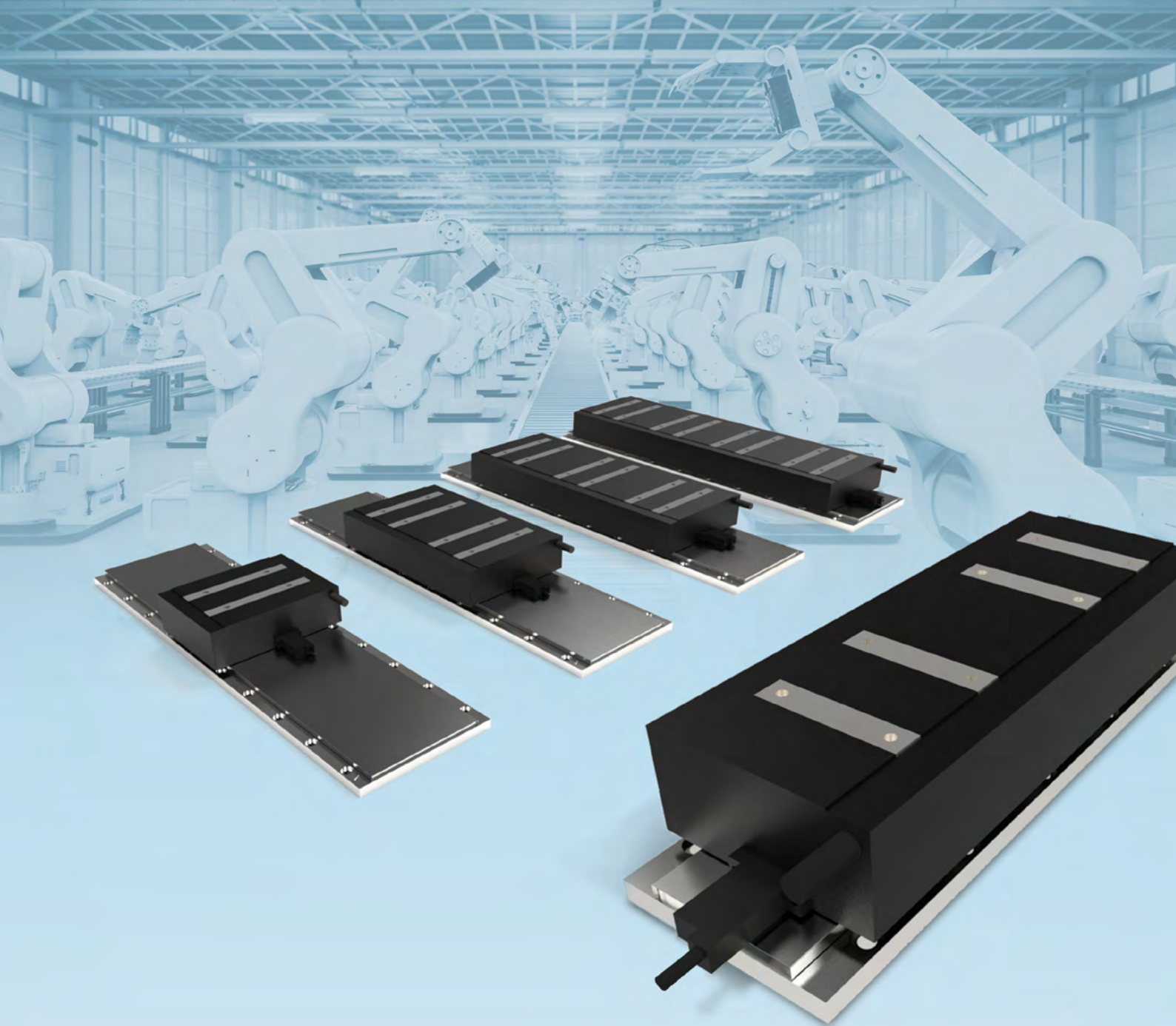

Core Type Linear Motor

Provides optimal solutions for various linear motion applications.

Features

- High force per size
- Easy assembly and design
- Minimize cogging
- Good heat dissipation

Model & Type

Motor Coil



①	LS
Series 명	LS Linear Motor
②	Type
C	Core
③	Assembly Width (mm)
046	046
058	058
072	072
100	100
165	165
④	Winding
S	Series
P	Parallel
T	Triple
D	Double
⑤	Rated Force (N)
008	80
015	150
024	240
030	300
⑥	Hall Sensor Type
D	Digital
N	No Hall Sensor

Magnet

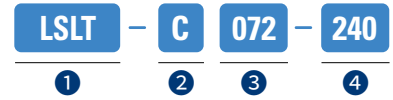

①	LS
Series 명	LS Linear Track
②	Type
C	Core
③	Assembly Width (mm)
058	058
072	072
100	100
165	165
④	Length (mm)
180	180
192	192
240	240

Core Type Force

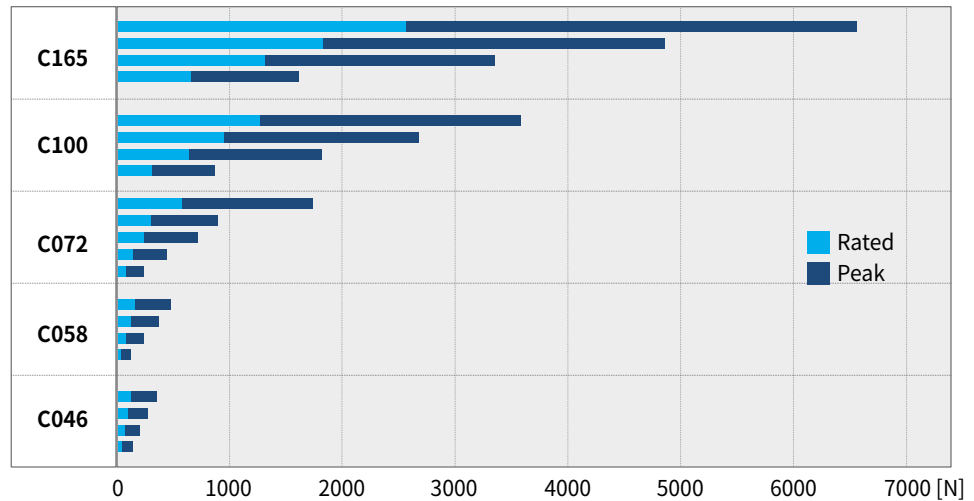

Specification

C046			S001	S003	S005	S007	
Force	Rated	[N]	18	36	54	72	
	Peak	[N]	54	108	162	216	
Current	Rated	[Arms]	1.3	1.3	1.3	1.3	
	Peak	[Arms]	3.9	3.9	3.9	3.9	
Back EMF constant (phase)			[Vrms/m/s]	4.9	9.5	14.7	19.0
Force constant			[N/Arms]	13.8	27.7	41.5	55.4
Resistance (line to line)			[Ω]	4.8	9.6	14.4	19.2
Inductance (line to line)			[mH]	5.1	9.7	14.4	19.8
Attraction force			[N]	100	200	300	400
Electrical cycle (N-N)			[mm]	18.0			
Length			[mm]	44.8	86	128.8	164.4
Width			[mm]	46			
Height			[mm]	23.5			
Weight			[kg]	0.25	0.5	0.7	0.9

Performance Curve

C046-S001

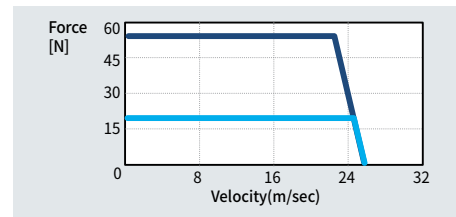

C046-S003

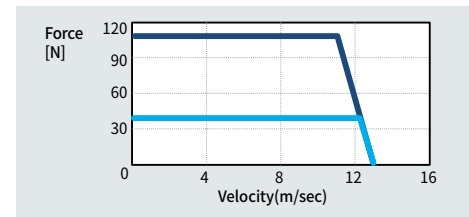

C046-S005

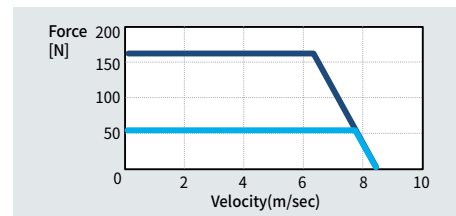

C046-S007

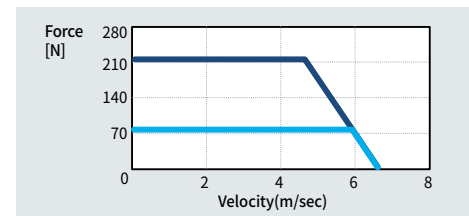

Motor Coil

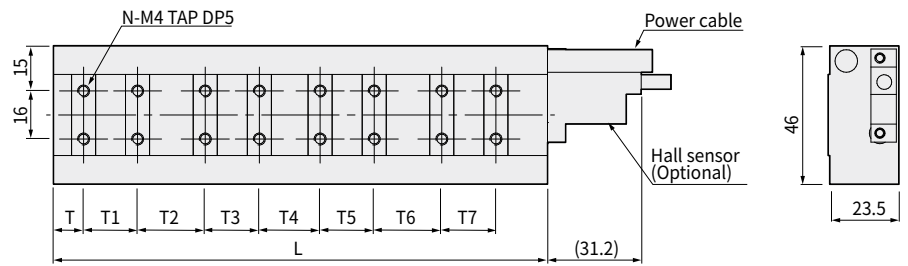

단위 : mm

Model	L	N	T	T1	T2	T3	T4	T5	T6	T7
C046-S001	44.8	4	10	18	-	-	-	-	-	-
C046-S003	86	8	10	18	22.5	18	-	-	-	-
C046-S005	128.8	12	10	18	24	18	24	18	-	-
C046-S007	164.4	16	10	18	22.5	18	20.25	18	22.5	18

Magnet

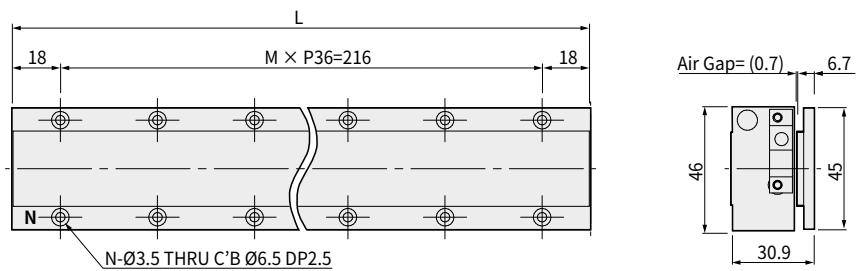

단위 : mm

Model	L	M	N	Weight (kg)
C046-180	180	4	10	0.3
C046-252	252	7	16	0.5

Connector

Motor Power

- Model No. : AMP 172167-1
- Mating connector : AMP 172159-1
- Cable length : 500mm Typical

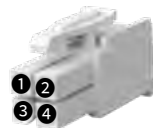

Pin No.	Color
1	U (Red)
2	V (Yellow)
3	W (Blue)
4	FG (Green)

Hall Sensor

- Model No. : MOLEX 5557-06R
- Mating connector : MOLEX 5559-06P
- Cable length : 500mm Typical



Pin No.	Color
1	Hall U (Orange)
2	Hall V (White)
3	Hall W (Blue)
4	+5V (Red)
5	GND (Black)
6	Not used

Specification

C058			S004	S008	S012	S016	P016	
Force	Rated	[N]	42	80	125	160	160	
	Peak	[N]	126	240	375	480	480	
Current	Rated	[Arms]	2.0	2.0	2.0	2.0	4.0	
	Peak	[Arms]	6.0	6.0	6.0	6.0	12.0	
Back EMF constant (phase)		[Vrms/m/s]	7.1	13.7	21.1	27.2	13.7	
Force constant		[N/Arms]	21.0	40.0	62.5	80.0	40.0	
Resistance (line to line)		[Ω]	4.0	7.9	11.9	15.8	4.0	
Inductance (line to line)		[mH]	6.1	11.2	16.3	22.3	5.6	
Attraction force		[N]	200	380	580	780	780	
Electrical cycle (N-N)		[mm]	24.0					
Length		[mm]	57.5	112.5	169.5	217		
Width		[mm]	53.0					
Height		[mm]	26.0					
Weight		[kg]	0.4	0.8	1.2	1.5		

Performance Curve

C058-S004

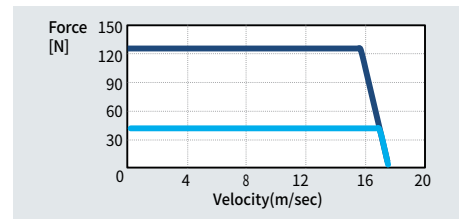

C058-S008

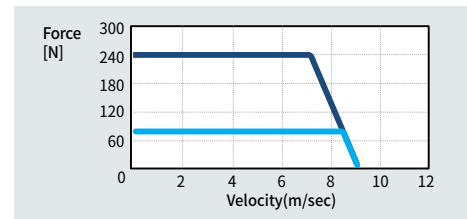

C058-S012

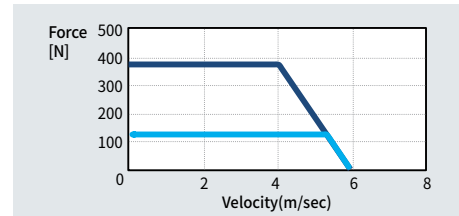

C058-□016

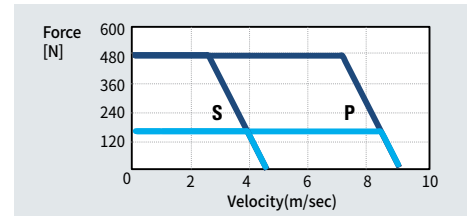

Motor Coil

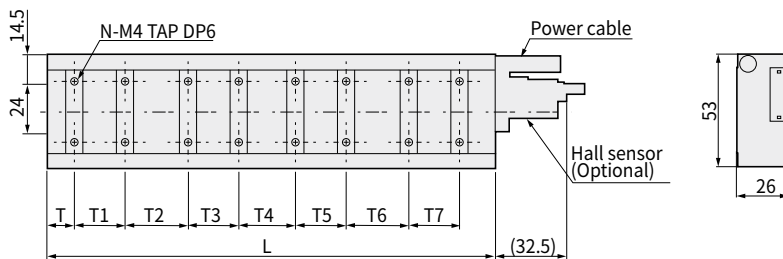

Unit : mm

Model	L	N	T	T1	T2	T3	T4	T5	T6	T7
C058-S004	57.5	4	13	24		-	-	-	-	-
C058-S008	112.5	8	13	24	30	24	-	-	-	-
C058-S012	169.5	12	13	24	32	24	32	24	-	-
C058-□016	217	16	13	24	30	24	27	24	30	24

Magnet

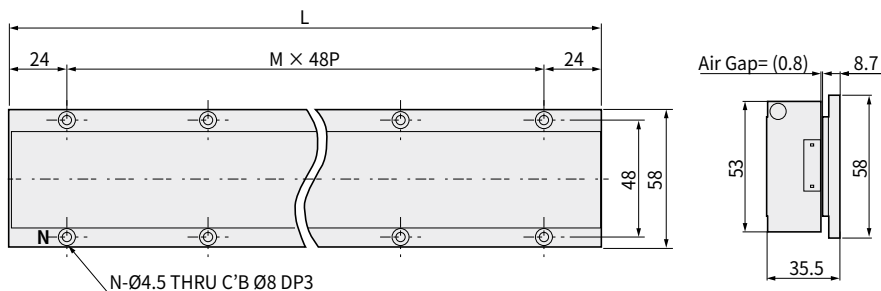

Unit : mm

Model	L	M	N	Weight (kg)
C058-192	192	3	8	0.6
C058-240	240	4	10	0.75

Connector

Motor Power

- Model No. : AMP 172167-1
- Mating connector : AMP 172159-1
- Cable length : 500mm Typical



Pin No.	Color
1	U (Red)
2	V (Yellow)
3	W (Blue)
4	FG (Green)

Hall Sensor

- Model No. : MOLEX 5557-06R
- Mating connector : MOLEX 5559-06P
- Cable length : 500mm Typical

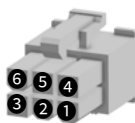

Pin No.	Color
1	Hall U (Orange)
2	Hall V (White)
3	Hall W (Blue)
4	+5V (Red)
5	GND (Black)
6	Not used

Specification

C072			S008	S015	S024	S030	S058	
Force	Rated	[N]	80	150	240	300	580	
	Peak	[N]	240	450	720	900	1740	
Current	Rated	[Arms]	3.8	3.8	3.8	3.8	5.1	
	Peak	[Arms]	11.4	11.4	11.4	11.4	15.3	
Back EMF constant (phase)		[Vrms/m/s]	7.0	13.5	20.9	26.8	38.1	
Force constant		[N/Arms]	21.1	39.5	63.2	78.9	113.7	
Resistance (line to line)		[Ω]	1.6	3.3	5.0	6.5	6.3	
Inductance (line to line)		[mH]	3.0	5.7	8.5	11.5	39.6	
Attraction force		[N]	400	750	1100	1500	1500	
Electrical cycle (N-N)		[mm]	30.0					
Length		[mm]	67.0	135.5	207.0	266.0	309.38	
Width		[mm]	67.0				70	
Height		[mm]	26.5				45.0	
Weight		[kg]	0.65	1.2	1.9	2.4	5.6	

Performance Curve

C072-S008

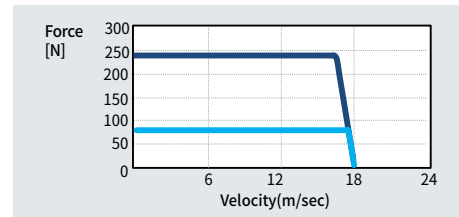

C072-S015

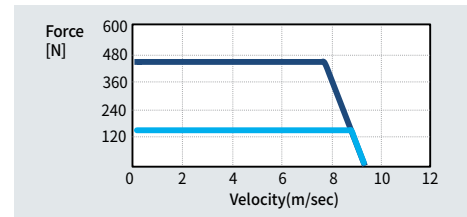

C072-S024

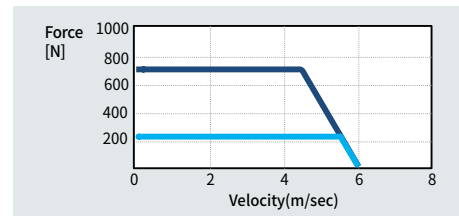

C072-S030

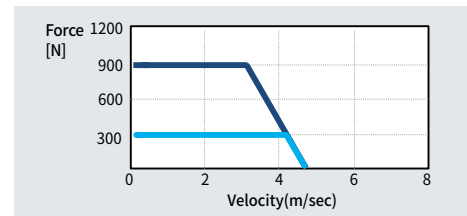

C072-S058

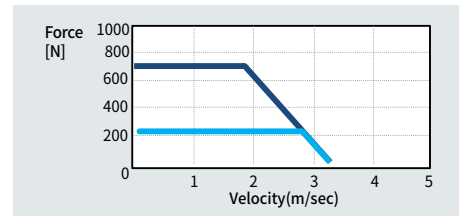

Motor Coil

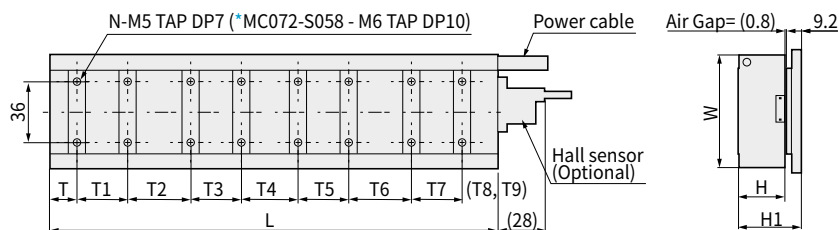

Unit: mm

Model	L	N	T	T1	T2	T3	T4	T5	T6	T7	T8	T9	W	H	H1
C072-S008	67	4	16	30	-	-	-	-	-	-	-	-	67	26.5	36.5
C072-S015	135.5	8	16	30	37.5	30	-	-	-	-	-	-	67	26.5	36.5
C072-S024	207	12	16	30	40	30	40	30	-	-	-	-	67	26.5	36.5
C072-S030	266	16	16	30	37.5	30	33.75	30	37.5	30	-	-	67	26.5	36.5
C072-S058	309.38	20	18.75	30	30	30	30	30	30	30	30	30	70	45	55

Magnet

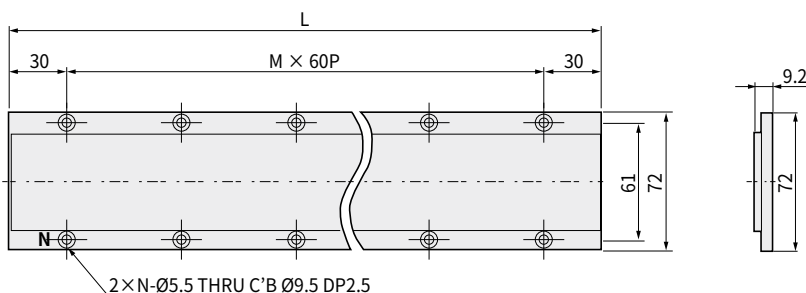

Unit: mm

Model	L	M	N	Weight (kg)
C072-180	180	2	6	0.75
C072-240	240	3	8	1

Connector

Motor Power

- Model No.: AMP 172167-1
- Mating connector: AMP 172159-1
- Cable length: 500mm Typical

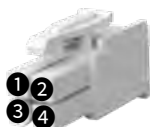

Pin No.	Color
1	U (Red)
2	V (Yellow)
3	W (Blue)
4	FG (Green)

Hall Sensor

- Model No.: MOLEX 5557-06R
- Mating connector: MOLEX 5559-06P
- Cable length: 500mm Typical

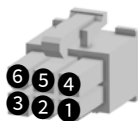

Pin No.	Color
1	Hall U (Orange)
2	Hall V (White)
3	Hall W (Blue)
4	+5V (Red)
5	GND (Black)
6	Not used

Specification

C100			S031	S062	P062	S092	T092	S123	P123	D123
Force	Rated	[N]	310	620	620	920	920	1230	1230	1230
	Peak	[N]	900	1790	1790	2680	2680	3570	3570	3570
Current	Rated	[Arms]	5.1	5.1	10.2	5.1	15.3	5.1	10.2	20.4
	Peak	[Arms]	19.2	19.2	38.4	19.2	57.6	19.2	38.4	76.8
Back EMF constant (phase)		[Vrms/m/s]	20.3	40.5	20.3	60.1	20.0	80.4	40.2	20.1
Force constant		[N/Arms]	60.8	121.6	60.8	180.4	60.1	241.2	120.6	60.3
Resistance (line to line)		[Ω]	3.2	6.3	1.6	9.5	1.1	12.6	3.2	0.8
Inductance (line to line)		[mH]	28.3	56.6	14.2	84.9	9.4	113.2	28.3	7.1
Attraction force		[N]	1120	2240	2240	3360	3360	4480	4480	4480
Electrical cycle (N-N)		[mm]	60.0							
Length		[mm]	126.3	263.8	406.3			525.05		
Width		[mm]	100.0							
Height		[mm]	48.0							
Weight		[kg]	3	6	9			12		

Performance Curve (AC 220V)

C100-S031

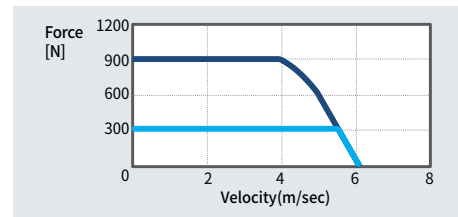

C100-□062

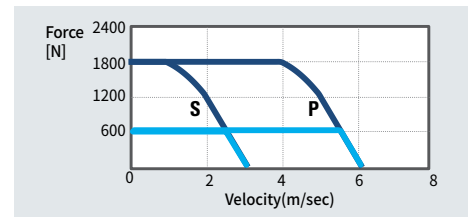

C100-□092

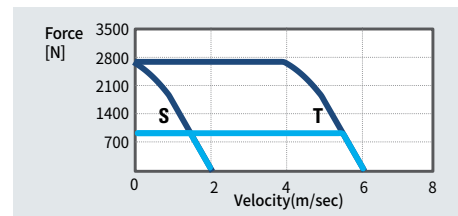

C100-□123

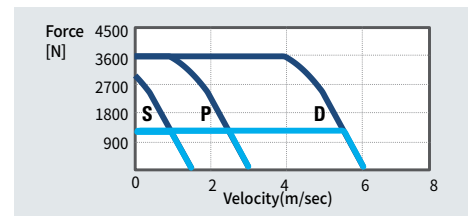

Performance Curve (AC 380V)

C100-S031

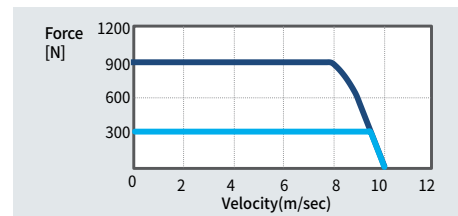

C100-□062

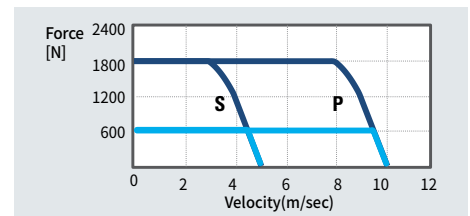

C100-□092

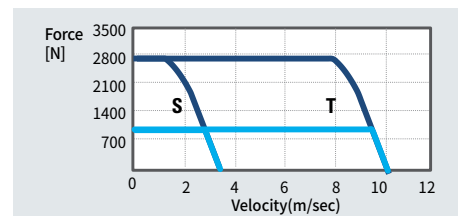

C100-□123

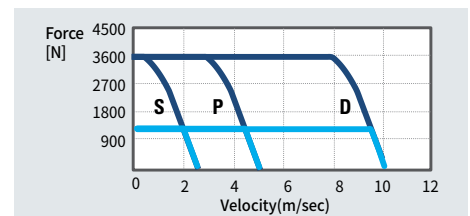

Motor Coil

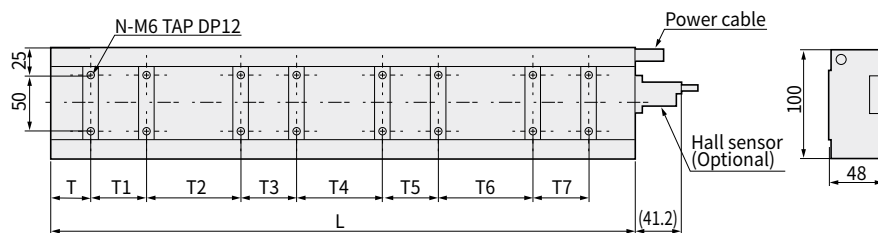

Unit : mm

Model	L	N	T	T1	T2	T3	T4	T5	T6	T7
C100-S031	126.3	4	36	50	-	-	-	-	-	-
C100-□062	263.8	8	36	50	85	50	-	-	-	-
C100-□092	406.3	12	36	50	90	50	90	50	-	-
C100-□123	525.05	16	36	50	85	50	77.5	50	85	50

Magnet

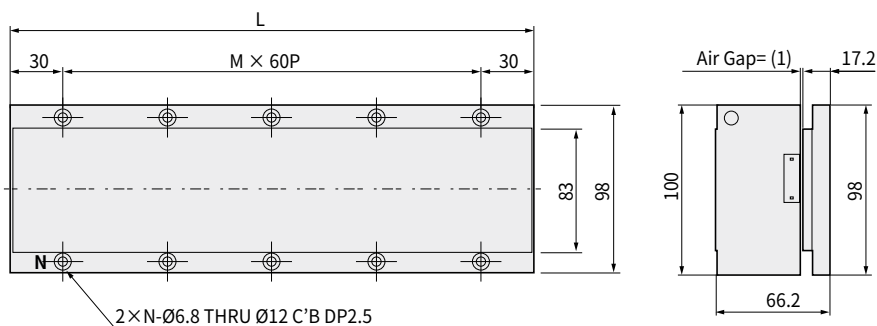

Unit : mm

Model	L	M	N	Weight (kg)
C100-180	180	2	6	1.95
C100-240	240	3	8	2.6

Connector

Motor Power



- Model No. : AMP 350779-1
- Mating connector : AMP 350780-1
- Cable length : 500mm Typical

Pin No.	Color
1	U (Red)
2	V (Yellow)
3	W (Blue)
4	FG (Green)

Hall Sensor

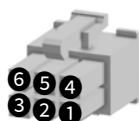

- Model No. : MOLEX 5557-06R
- Mating connector : MOLEX 5559-06P
- Cable length : 500mm Typical

Pin No.	Color
1	Hall U (Orange)
2	Hall V (White)
3	Hall W (Blue)
4	+5V (Red)
5	GND (Black)
6	Not used

Specification

C165			S063	S126	P126	S188	P188	T188	S251	P251
Force	Rated	[N]	630	1260	1260	1880	1880	1880	2510	2510
	Peak	[N]	1630	3260	3260	4890	4890	4890	6520	6520
Current	Rated	[Arms]	9.0	9.0	18.0	9.0	18.0	27.0	9.0	18.0
	Peak	[Arms]	33.9	33.9	67.8	33.9	67.8	101.7	33.9	67.8
Back EMF constant (phase)		[Vrms/m/s]	23.3	46.7	23.3	69.6	36.6	23.2	93.0	46.5
Force constant		[N/Arms]	70.0	140.0	70.0	208.9	104.4	69.6	278.9	139.4
Resistance (line to line)		[Ω]	1.6	3.2	0.8	4.8	2.4	0.5	6.4	1.6
Inductance (line to line)		[mH]	6.5	13.0	3.3	19.5	9.8	2.2	26.0	6.5
Attraction force		[N]	2550	4850	4850	7100	7100	7100	9400	9400
Electrical cycle (N-N)		[mm]	60.0							
Length		[mm]	126.3	263.8	406.3			525.05		
Width		[mm]	165.0							
Height		[mm]	48							
Weight		[kg]	5.1	10.1	15.2			20.2		

Performance Curve (AC 220V)

C165-S063

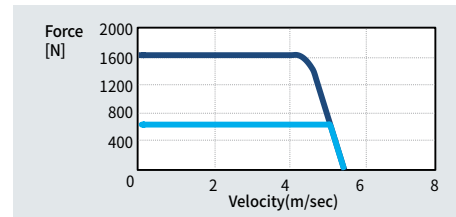

C165-□126

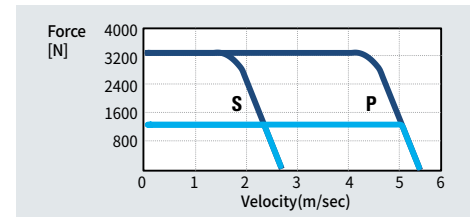

C165-□188

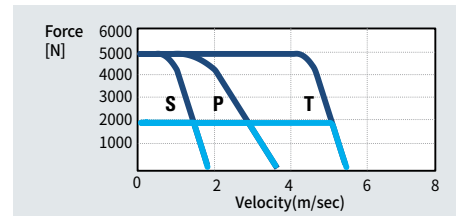

C165-□251

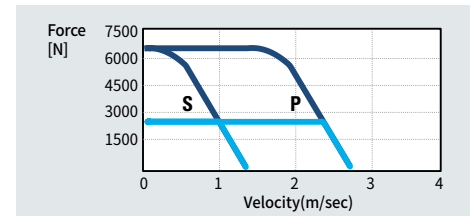

Performance Curve (AC 380V)

C165-S063

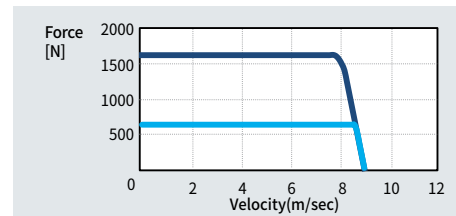

C165-□126

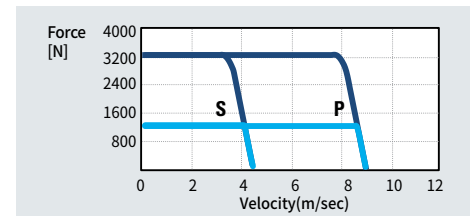

C165-□188

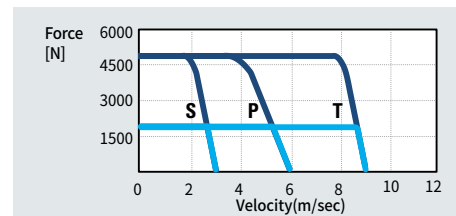

C165-□251

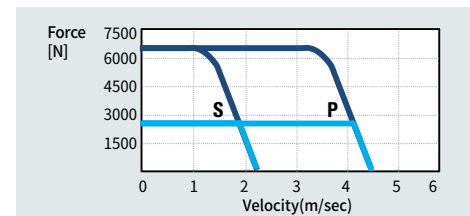

Motor Coil

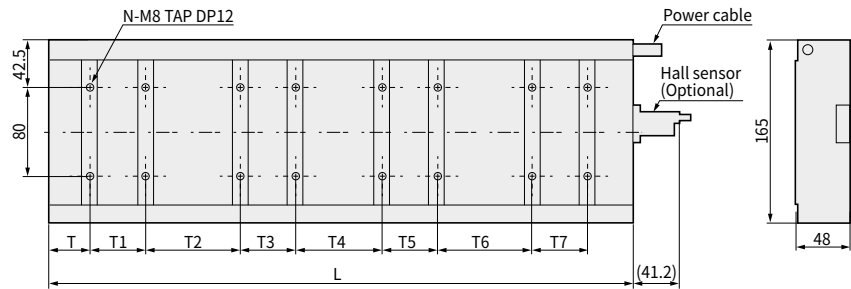

Unit: mm

Model	L	N	T	T1	T2	T3	T4	T5	T6	T7
C165-S063	126.3	4	36	50	-	-	-	-	-	-
C165-□126	263.8	8	36	50	85	50	-	-	-	-
C165-□188	406.3	12	36	50	90	50	90	50	-	-
C165-□251	525.05	16	36	50	85	50	77.5	50	85	50

Magnet

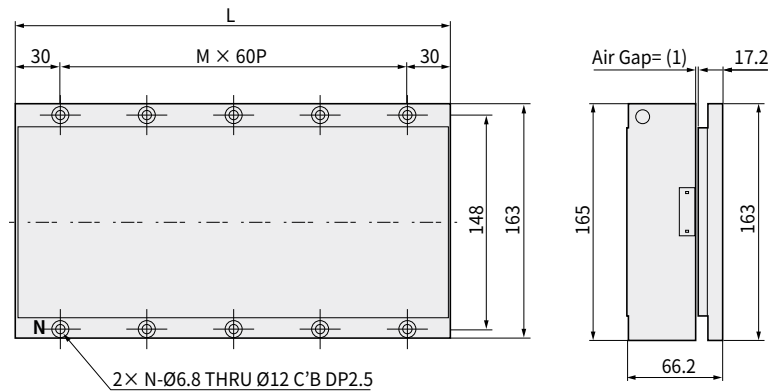

Unit: mm

Model	L	M	N	Weight (kg)
C165-180	180	2	6	3.4
C165-240	240	3	8	4.5

Connector

Motor Power



- Model No. : AMP 350779-1
- Mating connector : AMP 350780-1
- Cable length : 500mm Typical

Pin No.	Color
1	U (Red)
2	V (Yellow)
3	W (Blue)
4	FG (Green)

Hall Sensor



- Model No. : MOLEX 5557-06R
- Mating connector : MOLEX 5559-06P
- Cable length : 500mm Typical

Pin No.	Color
1	Hall U (Orange)
2	Hall V (White)
3	Hall W (Blue)
4	+5V (Red)
5	GND (Black)
6	Not used

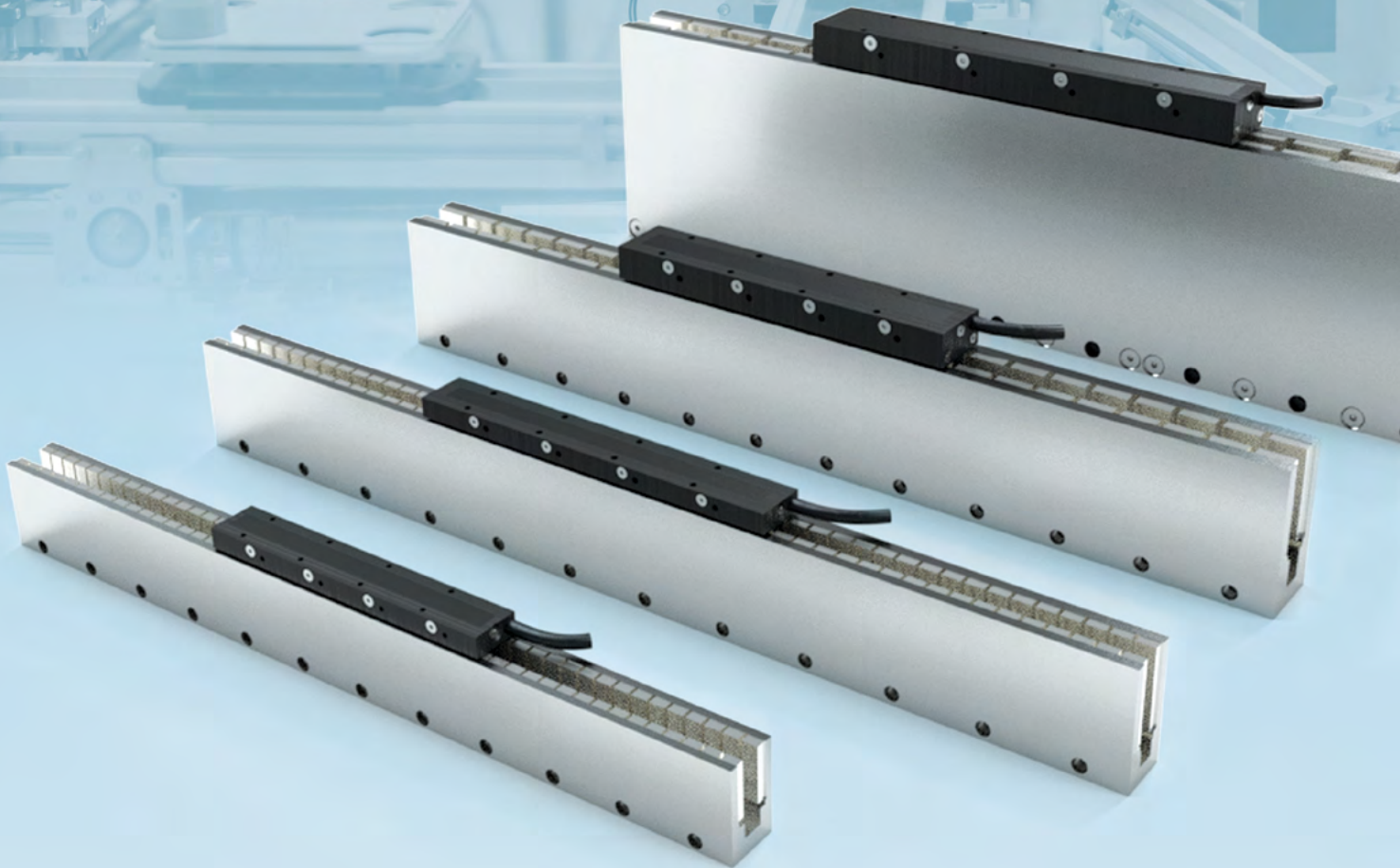

Coreless Type Linear Motor

Provides optimal solutions for precise manufacturing lines without cogging.

Features

- High force/high precision
- High speed
- Low speed ripple
- Rapid acceleration and deceleration
- Simple and safe assembly

Model & Type

Motor Coil



①	LSLM
Series	LS Linear Motor
②	Type
L	Coreless
③	Assembly Height (mm)
076	076
098	098
132	132
230	230
④	Winding
S	Series
P	Parallel
T	Triple
D	Double
⑤	Rated Force (N)
004	40
008	80
012	120
016	160
⑥	Hall Sensor Type
D	Digital
N	No Hall Sensor

Magnet



①	LSMG
Series	LS Linear Track
②	Type
L	Coreless
③	Assembly Height (mm)
076	076
098	098
132	132
230	230
④	Length (mm)
144	144
168	168
180	180
240	240
252	252

Coreless Type Force

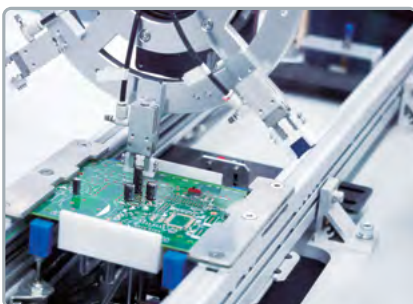
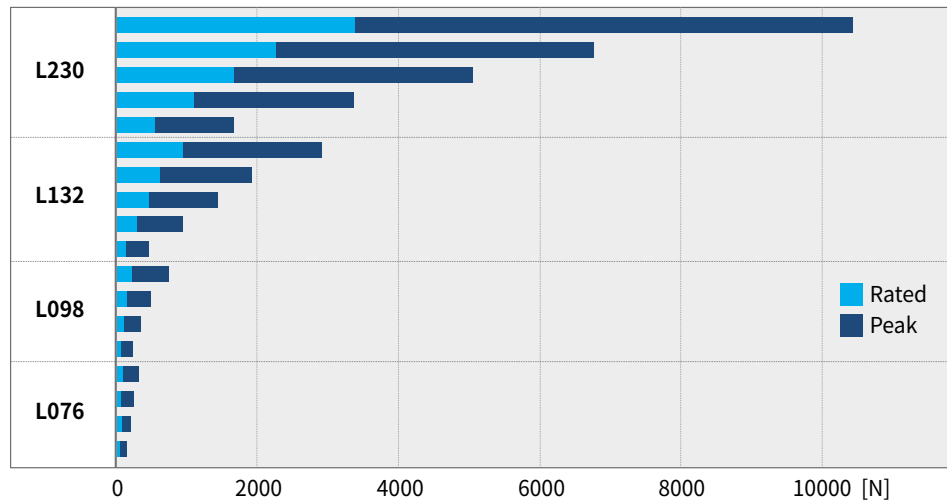

Specification

L076			S004	S006	S008	S010
Force	Rated	[N]	40	61	81	101
	Peak	[N]	122	183	245	306
Current	Rated	[Arms]	2.0	2.0	2.0	2.0
	Peak	[Arms]	5.9	5.9	5.9	5.9
Back EMF constant (phase)		[Vrms/m/s]	6.9	10.4	13.9	17.3
Force constant		[N/Arms]	20.8	31.2	41.6	52.0
Resistance (line to line)		[Ω]	8.4	12.7	16.9	21.1
Inductance (line to line)		[mH]	3.7	5.6	7.5	9.3
Attraction force		[N]	0			
Electrical cycle (N-N)		[mm]	24.0			
Length		[mm]	114.5	162.5	210.5	258.5
Weight		[kg]	0.45	0.65	0.84	1.05

Performance Curve

L076-S004

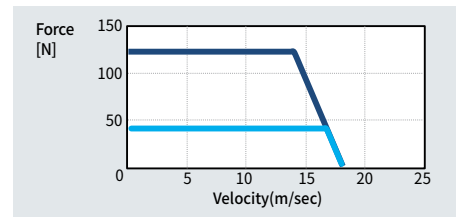

L076-S006

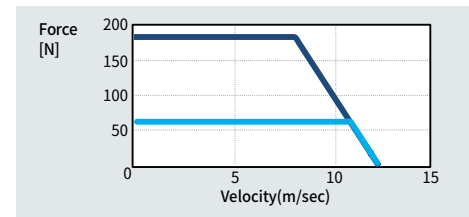

L076-S008

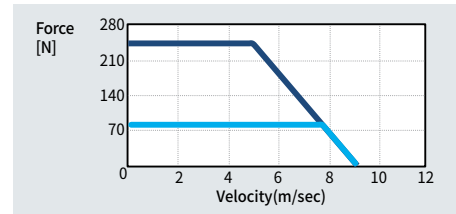

L076-S010

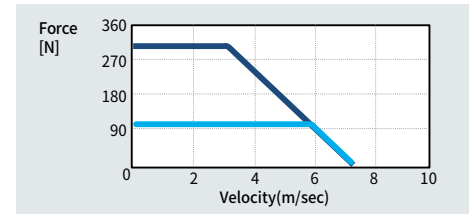

Motor Coil

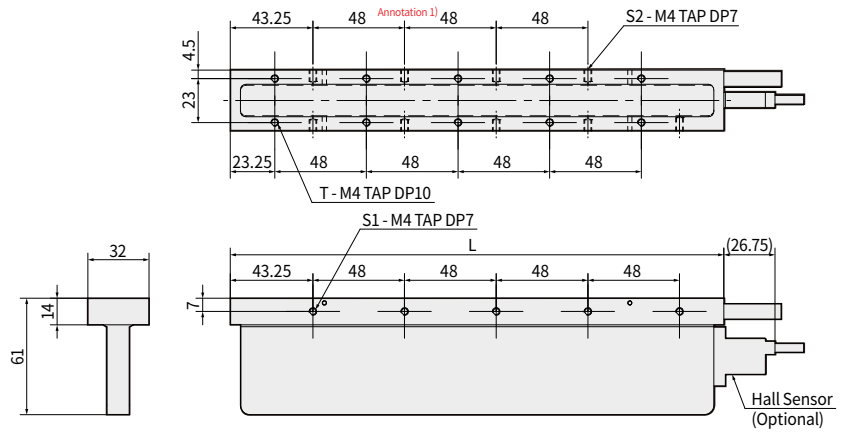

Unit : mm

Model	L	T	S1	S2
L076-S004	114.5	4	2	2
L076-S006	162.5	6	3	2
L076-S008	210.5	8	4	3
L076-S010	258.5	10	5	4

Annotation 1) 38mm only for L076-S004

Magnet

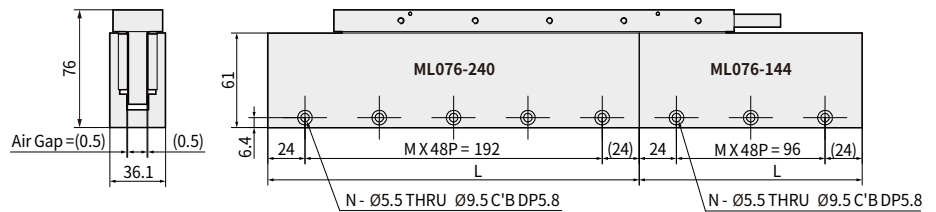

Unit : mm

Model	L	M	N	Weight (kg)
ML076-144	144	2	3	1.57
ML076-240	240	4	5	2.6

Connector

Motor Power



- Model No. : AMP 172167-1
- Mating connector : AMP 172159-1
- Cable length : 500mm Typical

Pin No.	Color
1	U (Red)
2	V (Yellow)
3	W (Blue)
4	FG (Green)

Hall Sensor

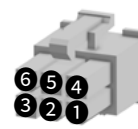

- Model No. : MOLEX 5557-06R
- Mating connector : MOLEX 5559-06P
- Cable length : 500mm Typical

Pin No.	Color
1	Hall U (Orange)
2	Hall V (White)
3	Hall W (Blue)
4	+5V (Red)
5	GND (Black)
6	Not used

Specification

L098			S008	S012	S017	P017	S025	P025
Force	Rated	[N]	85	127	170	170	255	255
	Peak	[N]	255	383	510	510	766	766
Current	Rated	[Arms]	1.6	1.6	1.6	3.2	1.6	3.2
	Peak	[Arms]	4.8	4.8	4.8	9.6	4.8	9.6
Back EMF constant (phase)		[Vrms/m/s]	17.7	26.6	35.5	17.7	53.2	26.6
Force constant		[N/Arms]	53.2	79.9	106.5	53.3	159.6	79.8
Resistance (line to line)		[Ω]	13.0	19.5	26.0	6.5	38.9	9.8
Inductance (line to line)		[mH]	9.5	14.2	18.9	4.8	28.4	7.1
Attraction force		[N]	0					
Electrical cycle (N-N)		[mm]	30.0					
Length		[mm]	150	210	270		390	
Weight		[kg]	0.55	0.85	1.1		1.65	

Performance Curve

L098-S008

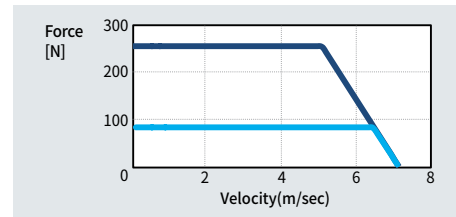

L098-S012

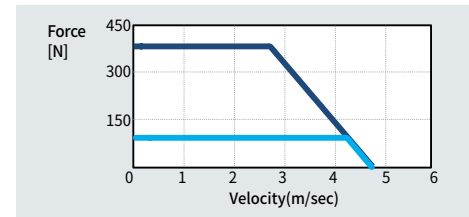

L098-S017

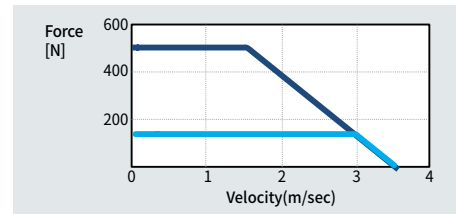

L098-P017

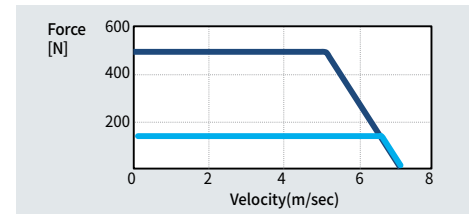

L098-S025

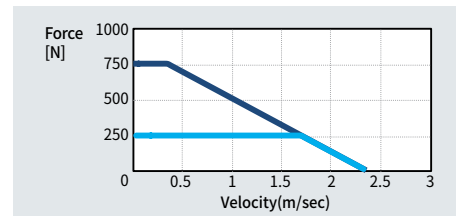

L098-P025

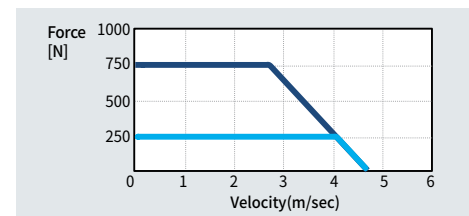

Specification

L132			S016	S032	S048	T048	S064	P064	P097	T097
Force	Rated	[N]	162	323	485	485	647	647	971	971
	Peak	[N]	486	971	1458	1458	1943	1943	2914	2914
Current	Rated	[Arms]	5.1	5.1	5.1	15.3	5.1	10.2	10.2	15.3
	Peak	[Arms]	15.3	15.3	15.3	45.9	15.3	30.6	30.6	45.9
Back EMF constant (phase)		[Vrms/m/s]	10.6	21.2	31.8	10.6	42.4	21.2	31.8	21.2
Force constant		[N/Arms]	31.8	63.5	95.3	31.8	127.0	63.5	95.3	63.5
Resistance (line to line)		[Ω]	2.5	5.0	7.4	0.8	9.9	2.5	3.7	1.7
Inductance (line to line)		[mH]	4.8	9.6	14.4	1.6	19.2	4.8	7.2	3.2
Attraction force		[N]	0							
Electrical cycle (N-N)		[mm]	60.0							
Length		[mm]	150	270	390		510		750	
Weight		[kg]	1.2	2.3	3.5		4.6		6.9	

Performance Curve (AC 220V)

L132-S016

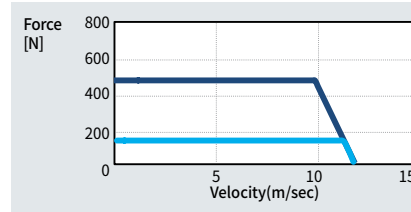

L132-S032

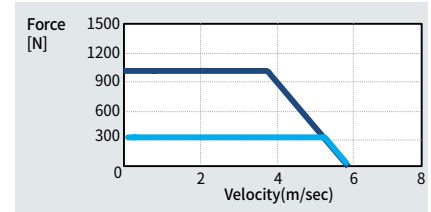

L132-□048

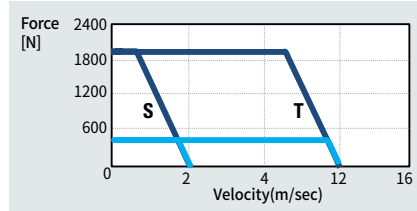

L132-□064

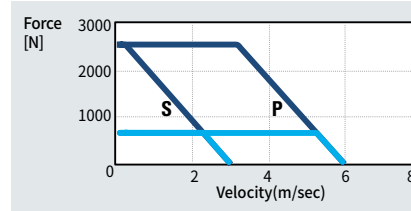

L132-□097

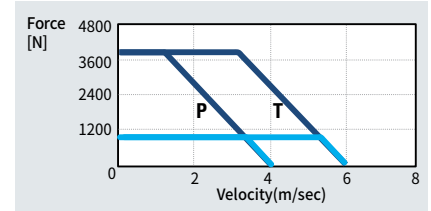

Performance Curve (AC 380V)

L132-S016

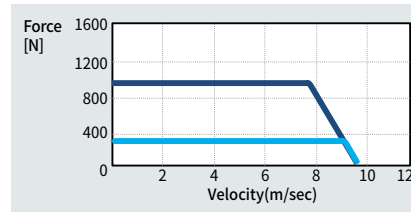

L132-S032

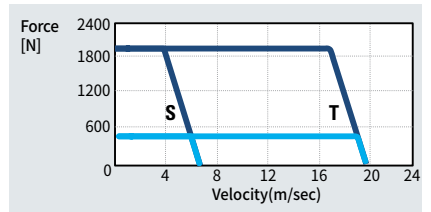

L132-□048

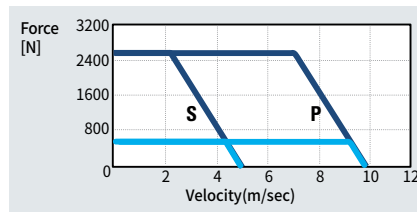

L132-□064

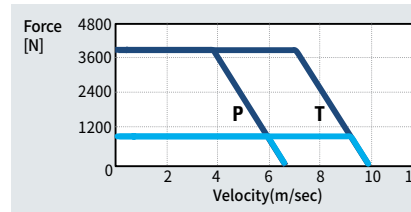

L132-□097

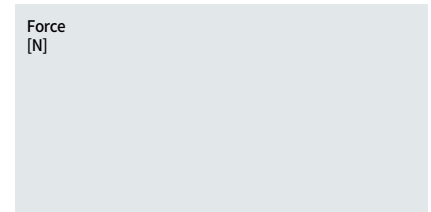

Motor Coil

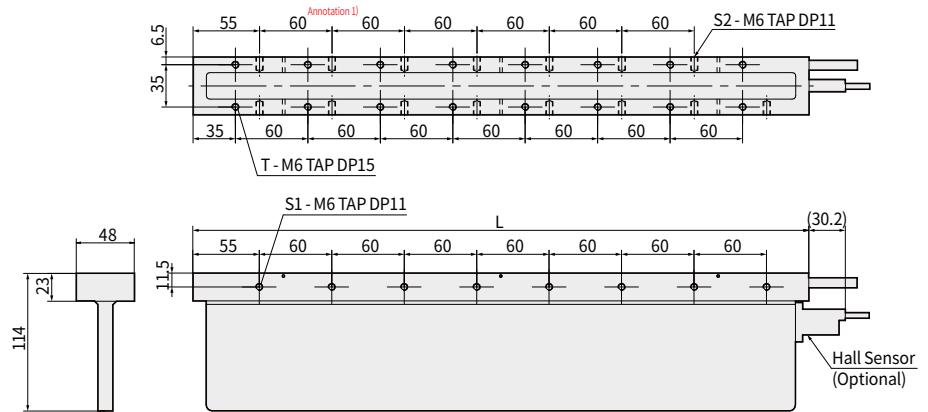

Unit: mm

Model	L	T	S1	S2
L132-S016	150	4	2	2
L132-S032	270	8	4	3
L132-□048	390	12	6	5
L132-□064	510	16	8	7
L132-□097	750	24	12	11

Annotation 1) 50mm only for L132-S016

Magnet

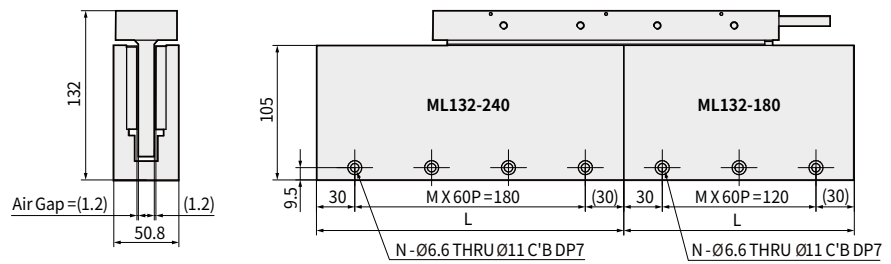

Unit: mm

Model	L	M	N	Weight (kg)
ML132-180	180	2	3	5.05
ML132-240	240	3	4	6.7

Connector

Motor Power



- Model No. : AMP 350779-1
- Mating connector : AMP 350780-1
- Cable length : 500mm Typical

Pin No.	Color
1	U (Red)
2	V (Yellow)
3	W (Blue)
4	FG (Green)

Hall Sensor



- Model No. : MOLEX 5557-06R
- Mating connector : MOLEX 5559-06P
- Cable length : 500mm Typical

Pin No.	Color
1	Hall U (Orange)
2	Hall V (White)
3	Hall W (Blue)
4	+5V (Red)
5	GND (Black)
6	Not used

Specification

L230			S056	S112	P112	S169	T169	P225	D225	P338	T338
Force	Rated	[N]	563	1127	1127	1691	1691	2255	2255	3382	3382
	Peak	[N]	1691	3382	3382	5073	5073	6765	6765	10148	10148
Current	Rated	[Arms]	9.1	9.1	18.2	9.1	27.3	18.2	36.4	18.2	27.3
	Peak	[Arms]	27.3	27.3	54.6	27.3	81.9	54.6	109.2	54.6	81.9
Back EMF constant (phase)		[Vrms/m/s]	20.7	41.3	20.7	62.0	20.7	41.3	20.7	62.0	41.3
Force constant		[N/Arms]	62.0	123.9	62.0	185.9	62.0	123.9	62.0	185.9	123.9
Resistance (line to line)		[Ω]	1.9	3.8	1.0	5.7	0.6	1.9	0.5	2.9	1.3
Inductance (line to line)		[mH]	1.5	3.0	0.8	4.5	0.5	1.5	0.4	2.3	1.0
Attraction force		[N]	0								
Electrical cycle (N-N)		[mm]	84.0								
Length		[mm]	194	362		530		698		1034	
Weight		[kg]	2.7	5.3		8		10.6		16	

Performance Curve (AC 220V)

L230-S056

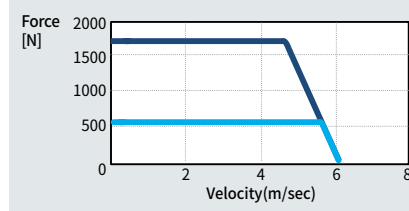

L230-□112

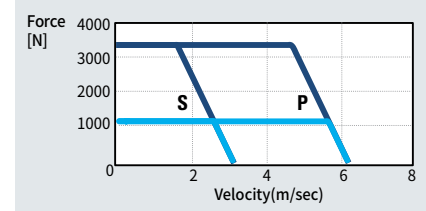

L230-□169

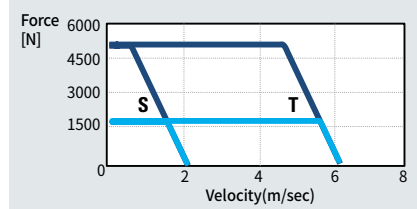

L230-□225

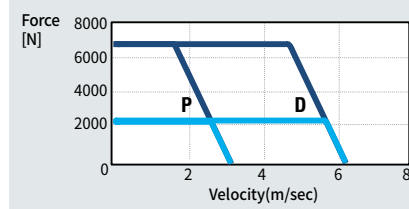

L230-□338

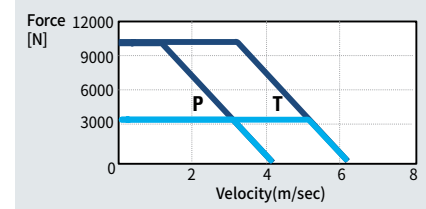

Performance Curve (AC 380V)

L230-S056

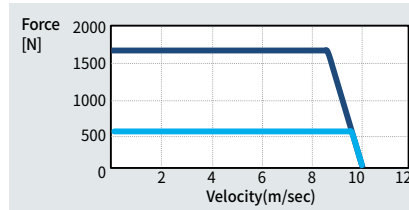

L230-□112

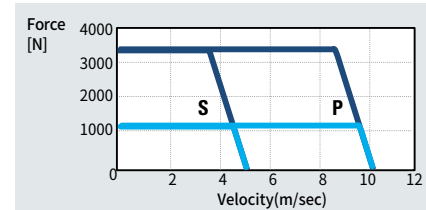

L230-□169

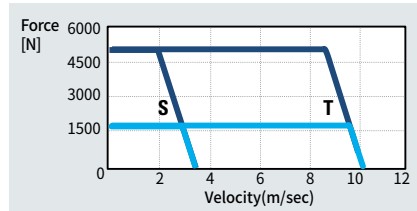

L230-□225

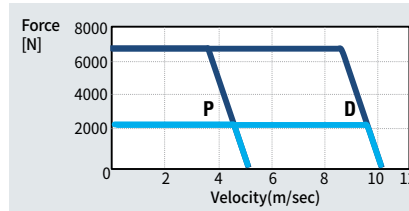

L230-□338

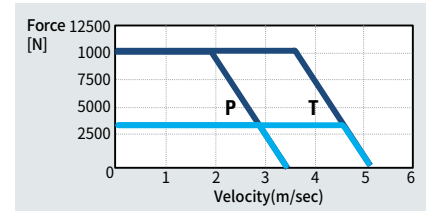

Motor Coil

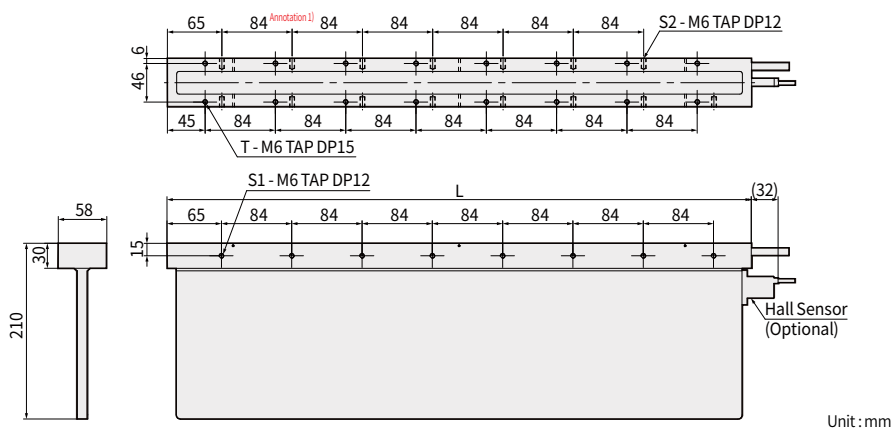

Model	L	T	S1	S2
L230-S056	194	4	2	2
L230-□112	362	8	4	3
L230-□169	530	12	6	5
L230-□225	698	16	8	7
L230-□338	1034	24	12	11

Annotation 1) 74mm only for L230-S056

Magnet

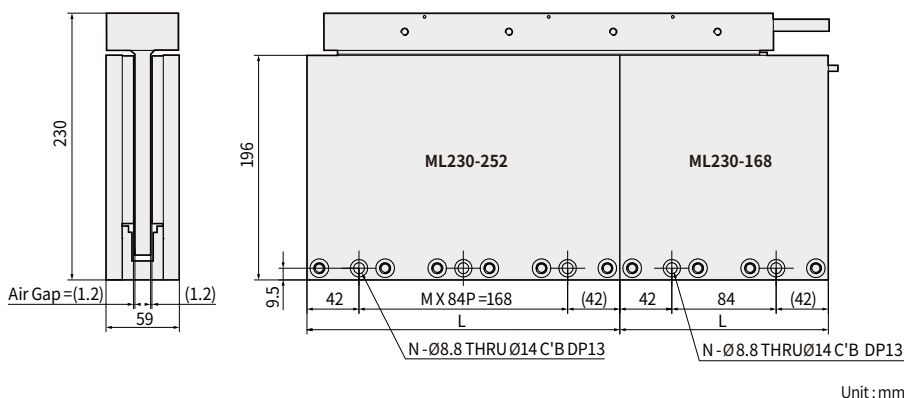

Model	L	M	N	Weight (kg)
ML230-168	168	-	2	11.2
ML230-252	252	2	3	16.7

Connector

Motor Power



- Model No. : AMP 350779-1
- Mating connector : AMP 350780-1
- Cable length : 500mm Typical

Pin No.	Color
1	U (Red)
2	V (Yellow)
3	W (Blue)
4	FG (Green)

※ L230-T169, D225, T338: Flying Leads Cable

Hall Sensor

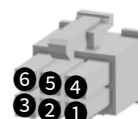

- Model No. : MOLEX 5557-06R
- Mating connector : MOLEX 5559-06P
- Cable length : 500mm Typical

Pin No.	Color
1	Hall U (Orange)
2	Hall V (White)
3	Hall W (Blue)
4	+5V (Red)
5	GND (Black)
6	Not used

**User-oriented Xmotion Servo Systems
complete your optimal solution.**

**Xmotion Servo Drive can be used in combination
with LS Linear Motor.**



Xmotion Series

Your motion systems visualize the perfect solution through the LS comprehensive product ranges for the optimal drives and applications.

Its high-performance vector, precision and speed control are user-friendly and cost effective.



[Note]

There are L7NH(F), L7P, and L7C drives that can be matched with linear motors. Since suitable drive products differ depending on the customer's operating environment, please contact overseas subsidiaries and branches at the back of this catalog and you can get product information in detail.

L7NHA Drive

Item		Type Name	L7NHA001U	L7NHA002U	L7NHA004U	L7NHA008U	L7NHA010U	L7NHA020U	L7NHA035U	L7NHA050U	L7NHA075U	L7NHA150U
Input Power	Main Power Supply	3 Phase AC200 ~ 230[V](-15 ~ +10[%]), 50 ~ 60[Hz]										
	Control Power Supply	Single Phase AC200 ~ 230[V](-15 ~ +10[%]), 50 ~ 60[Hz]										
Rated Current[A]			1.4	1.7	3.0	5.2	6.75	13.5	16.7	32	39.4	76
Peak Current[A]			4.2	5.1	9.0	15.6	20.25	40.5	50.1	90.88	98.5	190
Encoder Type		Quadrature(Incremental) BiSS-B, BiSS-C(Absolute, Incremental) Tamagawa Serial(Absolute, Incremental) EnDat 2.2, Sinusoidal, Analog Hall										
Control Performance	Speed Control Range	Maximum 1: 5000										
	Frequency Response	Maximum 1[kHz] or above(When the 19-bit Serial Encoder is applied)										
	Speed Variation Ratio	±0.01[%] or lower(When the load changes between 0 and 100%) ±0.1[%] or less(Temperature of 25°C±10)										
	Torque Control Repetition Accuracy	Within ±1%										
Communication Specifications Environment Communication	Communication Standard	FoE (Firmware download), EoE (Parameter setting by UDP, Tuning, Secondary function, Parameter copy) CoE (IEC 61158 Type12, IEC 61800-7 CIA 402 Drive profile)										
	Physical Layer	100BASE-TX(IEEE802.3)										
	Connector	RJ45 x 2										
	Communication Distance	Within connection between nodes 100[m]										
	DC(Distributed Clock)	By DC mode synchronism. minimum DC cycle: 250[us]										
	LED Display	LinkAct IN, LinkAct OUT, RUN, ERR										
Cia402 Drive Profile	Profile Position Mode, Profile Velocity Mode, Profile Torque Mode, Cyclic Synchronous Position Mode, Cyclic Synchronous Velocity Mode, Cyclic Synchronous Torque Mode, Homing Mode											
Digital Input / Output	Digital Input	Input Voltage range : DC 12[V] ~ DC 24[V] Total 8 input channels (allocable) Above 12 functions can be used selectively for assignment. (*POT, *NOT, *HOME, *STOP, *PCON, *GAIN2, *P_CL, *N_CL, PROBE1, PROBE2, EMG, A_RST)										
	Digital Output	Service rating: DC 24[V] ±10%, 120[mA] Total 4 input channels (allocable) Above 11 functions can be used selectively for assignment. (*BRAKE±, *ALARM±, *READY±, *ZSPD±, INPOS±, TLMT±, VLMT±, INSPD±, WARN±, TGOIN±, INPOS±)										
Safety Function		2 Input Channels (STO1, STO2), 1 Output Channels (EDM±)										
USB Communication	Function	Firmware download, Parameter setting, Tuning, Secondary function, Parameter copy										
	Communication Standard	USB 2.0 Full Speed (applies standard)										
	Connect	PC or USB storing medium										
Internal Function	Dynamic Braking	Standard built-in brake (activated when the servo alarm goes off or when the servo is off).										
	Regenerative Braking	Default built-in(excluding 15kW), external installation possible										
	Display Function	7 segments(5DIGIT)										
	Self-setting Function	The [MODE] key changes the content displayed in 7 segments										
	Additional Function	Auto gain tuning function										
	Protection Function	Overcurrent, overload, overvoltage, insufficient voltage, main power input problem, control power input problem, overspeed, motor cable, overheat(power module overheat, abnormal drive operation's temp), encoder problem, over-regenerative, sensor problem, communication problem										
Operation Environment	Operating Temperature / Storage Temperature	0 ~ 50[°C] / -20 ~ 70[°C]										
	Operating Humidity / Storage Humidity	Below 80[%]RH / Below 90[%]RH(avoid dew-condensation)										
	Environment	Indoor, Avoid corrosive, inflammable gas or liquid, and electrically conductive dust.										

L7NHB Drive

Item		Type Name	L7NHB010U	L7NHB020U	L7NHB035U	L7NHB050U	L7NHB075U	L7NHB150U
Input Power	Main Power Supply	3 Phase AC380 ~ 480[V](-15 ~ +10[%]), 50 ~ 60[Hz]						
	Control Power Supply	Single Phase AC380 ~ 480[V](-15 ~ +10[%]), 50 ~ 60[Hz]						
Rated Current[A]			3.7	8	10.1	17.5	22.8	39
Peak Current[A]			11.1	24	30.3	47.25	57	97.5
Encoder Type		Quadrature(Incremental) BiSS-B, BiSS-C(Absolute, Incremental) Tamagawa Serial(Absolute, Incremental) EnDat 2.2, Sinusoidal, Analog Hall						
Control Performance	Speed Control Range	Maximum 1: 5000						
	Frequency Response	Maximum 1[kHz] or above(When the 19-bit Serial Encoder is applied)						
	Speed Variation Ratio	$\pm 0.01[\%]$ or lower(When the load changes between 0 and 100%) $\pm 0.1[\%]$ or less(Temperature of 25°C ± 10)						
	Torque Control Repetition Accuracy	Within $\pm 1\%$						
Communication Specifications Environment Communication	Communication Standard	FoE (Firmware download) EoE (Parameter setting by UDP, Tuning, Secondary function, Parameter copy) CoE (IEC 61158 Type12, IEC 61800-7 CIA 402 Drive profile)						
	Physical Layer	100BASE-TX(IEEE802.3)						
	Connector	RJ45x2						
	Communication Distance	Within connection between nodes 100[m]						
	DC(Distributed Clock)	By DC mode synchronism. minimum DC cycle: 250[us]						
	LED Display	LinkAct IN, LinkAct OUT, RUN, ERR						
	Cia402 Drive Profile	Profile Position Mode, Profile Velocity Mode, Profile Torque Mode, Cyclic Synchronous Position Mode Cyclic Synchronous Velocity Mode, Cyclic Synchronous Torque Mode, Homing Mode						
Digital Input / Output	Digital Input	Input Voltage range : DC 12[V] ~ DC 24[V] Total 8 input channels (allocable) Above 12 functions can be used selectively for assignment. (*POT, *NOT, *HOME, *STOP, *PCON, *GAIN2, *P_CL, *N_CL, PROBE1, PROBE2, EMG, A_RST)						
	Digital Output	Service rating: DC 24[V] $\pm 10\%$, 120[mA] Total 4 input channels (allocable) Above 11 functions can be used selectively for assignment. (*BRAKE \pm , *ALARM \pm , *READY \pm , *ZSPD \pm , INPOS \pm , TLMT \pm , VLMT \pm , INSPD \pm , WARN \pm , TGON \pm , INPOS \pm)						
Safety Function		2 Input Channels (STO1, STO2), 1 Output Channels (EDM \pm)						
USB Communication	Function	Firmware download, Parameter setting, Tuning, Secondary function, Parameter copy						
	Communication Standard	USB 2.0 Full Speed (applies standard)						
	Connect	PC or USB storing medium						
Internal Function	Dynamic Braking	Standard built-in brake (activated when the servo alarm goes off or when the servo is off).						
	Regenerative Braking	Default built-in(excluding 15kW), external installation possible						
	Display Function	7 segments(5DIGIT)						
	Self-setting Function	The [MODE] key changes the content displayed in 7 segments						
	Additional Function	Auto gain tuning function						
	Protection Function	Overcurrent, overload, overvoltage, insufficient voltage, main power input problem, control power input problem, overspeed, motor cable, overheat(power module overheat, abnormal drive operation's temp), encoder problem, over-regenerative, sensor problem, communication problem						
Operation Environment	Operating Temperature / Storage Temperature	0 ~ 50[°C] / -20 ~ 70[°C]						
	Operating Humidity / Storage Humidity	Below 80[%]RH / Below 90[%]RH(avoid dew-condensation)						
	Environment	Indoor, Avoid corrosive, inflammable gas or liquid, and electrically conductive dust.						

L7PA Drive

Item		Type Name	L7PA001U	L7PA002U	L7PA004U	L7PA008U	L7PA010U	L7PA020U	L7PA035U	L7PA050U	L7PA075U	L7PA150U
Input Power	Main Power Supply	3 Phase AC200 ~ 230[V](-15 ~ +10[%]), 50 ~ 60[Hz]										
	Control Power Supply	Single Phase AC200 ~ 230[V](-15 ~ +10[%]), 50 ~ 60[Hz]										
Rated Current[A]			1.4	1.7	3.0	5.2	6.75	13.5	16.7	32	39.4	76
Peak Current[A]			4.2	5.1	9.0	15.6	20.25	40.5	50.1	90.88	98.5	190
Encoder Type		Quadrature(Incremental) BiSS-B, BiSS-C(Absolute, Incremental) Tamagawa Serial(Absolute, Incremental) EnDat 2.2 Sinusoidal Analog Hall										
Control Performance	Speed Control Range	Maximum 1: 5000										
	Frequency Response	Maximum 1 [kHz] or above (When using 19bit Serial Encoder)										
	Speed Variation Ratio	± 0.01 [%] or lower [when load changes between 0 and 100%] ± 0.1 [%] or lower [temperature 25 $\pm 10^{\circ}\text{C}$]										
	Accel/Decel Time	Straight or S-curve acceleration/deceleration (0~10,000[ms], 0~1,000[ms] Unit configurable)										
	Input Frequency	1[Mpps], line drive / 200[kpps], Open Collector										
	Input Pulse Type	Symbol + Pulse Series, CW+CCW, A/B Phase										
RS422 Communication Specifications	Communication Specifications	ANSI/TIA/EIA-422 Standard Specifications										
	Communication Protocol	MODBUS-RTU										
	Connector	RJ45x2										
	Synchro Method	Asynchronous										
	Transmission Speed	9600 /19200/38400/57600 [bps], Can be configured at [0x3002]										
	Transmission Distance	Maximum 200 [m]										
	Power Consumption	100[mA]										
	Terminating Resistance	Dip S/W(On/Off), Built-In 120 Ω										
Input / Output Signal	Digital Input	Input voltage range: DC 12[V] ~ DC 24[V] Total 16 input channel (allocatable) 32 function inputs can be selectively allocated (*SV_ON, *POT, *NOT, *A-RST, *START, *STOP, *REGT, *EMG, *HOME, *HSTART, *ISEL0, *ISEL1, *ISEL2, *ISEL3, *ISEL4, *ISEL5, PCON, GAIN2, P_CL, N_CL, MODE, PAUSE, ABSRQ, JSTART, JDIR, PCLR, AOVr, SPD1/LVSF1, SPD2/LVSF2, SPD3, PROBE1, PROBE2)										
	Digital Output	Use rating: DC 24[V] $\pm 10\%$, 120[mA] Total 8 input channel (allocatable) 19 function inputs can be selectively allocated (*ALARM \pm , *READY \pm , *BRAKE \pm , *INPOS1 \pm , *ORG \pm , *EOS \pm , *TGON \pm , *TLMT \pm , VLMT \pm , INSPD \pm , ZSPD \pm , WARN \pm , INPOS2 \pm , IOUT0 \pm , IOUT1 \pm , IOUT2 \pm , IOUT3 \pm , IOUT4 \pm , IOUT5 \pm)										
Analog Input / output	Analog input	Total 2 channels, analog speed override input(-10[V] ~ +10[V]), analog torque command input(-10[V] ~ +10[V])										
	Analog output	Total 2 channels, 15 function inputs can be selectively allocated										
USB Communication	Protection	Firmware download, parameter setting, tuning, auxiliary function, parameter copy										
	Communication Specifications	Complies with USB 2.0 Full Speed Specifications										
	Connection Device	PC or USB storage media										
Built-in functions	Dynamic Braking	Standard built-in(activated by servo alarm or servo OFF)										
	Regenerative Braking	Default built-in(excluding 15kW), external installation possible										
	Display	7 Segment(5 DIGIT)										
	Setting Function	Drive node address can be set using rotary switch										
	Additional Function	Gain tuning, alarm history, JOG operation, origin search										
	Protective Function	Excessive current, overload, excessive current limit, overheating, excessive voltage, low voltage, excessive speed, encoder fail, position following fail, current sensing fail										
Operation Environment	Operating Temperature / Storage Temperature	0 ~ 50[$^{\circ}\text{C}$] / -20 ~ 70[$^{\circ}\text{C}$]										
	Operating Humidity / Storage Humidity	Below 80[%]RH / Below 90[%]RH(avoid dew-condensation)										
	Environment	Indoor, Avoid corrosive, inflammable gas or liquid, and electrically conductive dust.										

L7PB Drive

Item		Type Name	L7PB010U	L7PB020U	L7PB035U	L7PB050U	L7PB075U	L7PB150U
Input Power	Main Power Supply	3 Phase AC380 ~480[V](-15 ~ +10[%]), 50 ~ 60[Hz]						
	Control Power Supply	Single Phase AC380 ~ 480[V](-15 ~ +10[%]), 50 ~ 60[Hz]						
Rated Current[A]			3.7	8	10.1	17.5	22.8	39
Peak Current[A]			11.1	24	30.3	47.25	57	97.5
Encoder Type		Universal Encoder Feedback Quadrature(Incremental) BiSS-B, BiSS-C(Absolute, Incremental) Tamagawa Serial(Absolute, Incremental) EnDat 2.2 Sinusoidal Analog Hall						
Control Performance	Speed Control Range	Maximum 1: 5000						
	Frequency Response	Maximum 1 [kHz] or above (When using 19bit Serial Encoder)						
	Speed Variation Ratio	±0.01 [%] or lower [when load changes between 0 and 100%] ±0.1[%]orlower[temperature25 ±10°C]						
	Accel/Decel Time	Straight or S-curve acceleration/deceleration (0~10,000[ms], 0~1,000[ms] Unit configurable)						
	Input Frequency	1[Mpps], line drive / 200[kpps], Open Collector						
	Input Pulse Type	Symbol + Pulse Series, CW+CCW, A/B Phase						
RS422 Communication Specifications	Communication Specifications	ANSI/TIA/EIA-422 Standard Specifications						
	Communication Protocol	MODBUS-RTU						
	Connector	RJ45x2						
	Synchro Method	Asynchronous						
	Transmission Speed	9600 /19200/38400/57600 [bps], Can be configured at [0x3002]						
	Transmission Distance	Maximum 200 [m]						
	Power Consumption	100[mA]						
	Terminating Resistance	Dip S/W(On/Off), Built-In 120Ω						
Input / Output Signal	Digital Input	Input voltage range: DC 12[V] ~ DC 24[V] Total 16 input channel (allocatable) 30 function inputs can be selectively allocated (*SV_ON, *POT, *NOT, *A-RST, *START, *STOP, *REGT, *EMG, *HOME, *HSTART, *ISEL0, *ISEL1, *ISEL2, *ISEL3, *ISEL4, *ISEL5, PCON, GAIN2, P_CL, N_CL, PAUSE ,ABSRQ, JSTART, JDIR, PCLR, SPD1/LVSF1, SPD2/LVSF2, SPD3, AOV, MODE,)						
	Digital Output	Use rating: DC 24[V] ±10%, 120[mA] Total 8 input channel (allocatable) 19 function inputs can be selectively allocated (*ALARM±, *READY±, *BRAKE±, *INPOS1±, *ORG±, *EOS±, *TGON±, *TLMT±, VLMT±, INSPD±, ZSPD±, WARN±, INPOS2±, IOUT0±, IOUT1±, IOUT2± IOUT3±, IOUT4±, IOUT5±)						
Analog Input / output	Analog input	Total 2 channels, analog speed override input(-10[V] ~ +10[V]), analog torque command input(-10[V] ~ +10[V])						
	Analog output	Total 2 channels, 15 function inputs can be selectively allocated						
USB Communication	Protection	Firmware download, parameter setting, tuning, auxiliary function,parameter copy						
	Communication Standard	Complies with USB 2.0 Full Speed Specifications						
	Connection Device	PC or USB storage media						
Built-in functions	Dynamic Braking	Standard built-in(activated by servo alarm or servo OFF)						
	Regenerative Braking	Default built-in(excluding 15kW), external installation possible						
	Display	7 Segment(5 DIGIT)						
	Setting Function	Drive node address can be set using rotary switch						
	Additional Function	Gain tuning, alarm history, JOG operation, origin search						
	Protective Function	Excessive current, overload, excessive current limit, overheating, excessive voltage, low voltage, excessive speed, encoder fail, position following fail, current sensing fail						
Operation Environment	Operating Temperature / Storage Temperature	0 ~ 50[°C] / -20 ~ 70[°C]						
	Operating Humidity / Storage Humidity	Below80[%]RH / Below 90[%]RH(avoid dew-condensation)						
	Environment	Indoor, Avoid corrosive, inflammable gas or liquid, and electrically conductive dust.						

L7NHFA Drive

Item	Type Name	L7NHFA004U	L7NHFA010U	L7NHA035U	L7NHA050U	L7NHA075U
Input Power	Main Power Supply	3 Phase AC200 ~ 230[V](-15 ~ +10[%]), 50 ~ 60[Hz]				
	Control Power Supply	Single Phase AC200 ~ 230[V](-15 ~ +10[%]), 50 ~ 60[Hz]				
Rated Current[A]		3.0	6.75	16.7	32	39.4
Peak Current[A]		9.0	20.25	50.1	90.88	98.5
1st Encoder Encoder A		Quadrature (Incremental) BiSS-B, BiSS-C (Absolute, Incremental) Tamagawa Serial (Absolute, Incremental) EnDat 2.2, Sinusoidal, Analog Hall				
2nd Encoder Encoder B		Quadrature (Incremental), SSI Sinusoidal, Analog Hall (Analog to BiSS converter)				
Control Performance	Speed Control Range	Maximum 1: 5000				
	Frequency Response	Maximum 1[kHz] or above(When the 19-bit Serial Encoder is applied)				
	Speed Variation Ratio	± 0.01 [%] or lower(When the load changes between 0 and 100%) ± 0.1 [%] or less(Temperature of 25°C[± 10])				
	Torque Control Repetition Accuracy	Within ± 1 %				
	Input Frequency	4[Mpps], Lind Drive				
	Input Pulse Method	Symbol+Pulse series,CW+CCW,PhaseA/B				
EtherCAT Communication Specifications	Communication Standard	FoE (Firmware download) EoE (Parameter setting by UDP, Tuning, Secondary function, Parameter copy) CoE (IEC 61158 Type12, IEC 61800-7 CIA 402 Drive profile)				
	Physical Layer	100BASE-TX(IEEE802.3)				
	Connector	RJ45x2				
	Communication Distance	Within connection between nodes 100[m]				
	DC(Distributed Clock)	By DC mode synchronism. minimum DC cycle: 250[us]				
	LED Display	LinkAct IN, LinkAct OUT, RUN, ERR				
	Cia402 Drive Profile	Profile Position Mode, Profile Velocity Mode. Profile Torque Mode, Cyclic Synchronous Position Mode Cyclic Synchronous Velocity Mode, Cyclic Synchronous Torque Mode, Homing Mode				
Digital Input / Output	Digital Input	Input Voltage range : DC12[V] ~ DC 24[V] Total 6 input channels(allocable) Above 15 functions can be used selectively for assignment. (*POT, *NOT, *HOME, *STOP, *PCON, *GAIN2, *P_CL, *N_CL, PROBE1, PROBE2, EMG, A_RST, SV_ON, LVSF, LVSF2) * Default signal				
	Digital Output	Total 3 input channels (allocable) Total 11 output can be used selectively for assignment. (*BRAKE \pm , *ALARM \pm , *READY \pm , *ZSPD \pm , INPOS \pm , TLMT \pm , VLMT \pm , INSPD \pm , WARN \pm , TGON \pm , INPOS2 \pm) * Default signal				
	Analog Output	Total 2 channels (allocable), Total 25 output can be used selectively for assignment.				
Safety Function		2 Input Channels (STO1, STO2)				
USB Communication	Function	Firmware download, Parameter setting, Tuning, Secondary function, Parameter copy				
	Communication Standard	USB 2.0 Full Speed (applies standard)				
	Connect	PC or USB storing medium				
Internal Function	Dynamic Braking	Standard built-in brake (activated when the servo alarm goes off or when the servo is off).				
	Regenerative Braking	Default built-in(excluding 15kW), external installation possible				
	Display Function	7 segments(5DIGIT)				
	Self-setting Function	The [MODE] key changes the content displayed in 7 segments				
	Additional Function	Auto gain tuning function				
	Protection Function	Overcurrent, overload, overvoltage, insufficient voltage, overspeed, overheat(power module overheat, abnormal drive operation's temp), encoder problem, position tracking problem, current sensing problem				
Operation Environment	Operating Temperature / Storage Temperature	0 ~ 50[°C] / -20 ~ 70[°C]				
	Operating Humidity / Storage Humidity	Below 80[%]RH / Below 90[%]RH(avoid dew-condensation)				
	Environment	Indoor, Avoid corrosive, inflammable gas or liquid, and electrically conductive dust.				

L7C Drive

Item	Type Name	L7CA001U	L7CA002U	L7CA004U	L7CA008U	L7CA010U
Input Power		Single phase AC200 ~ 230[V] (-15~+10%), 50~60[Hz]				
Rated Current[A]		1.4	1.7	3.0	5.2	6.75
Peak Current[A]		4.2	5.1	9.0	15.6	20.25
Encoder Type		Quadrature (Incremental), Biss-B, Biss-C (Absolute, Incremental)				
Control Performance	Speed Control Range	Maximum 1:5000				
	Frequency Response	Maximum 1[KHz] or above (When using 19Bit Serial Encoder)				
	Speed Variation Ratio	±0.01 [%] or lower [when load changes between 0 and 100%] ±0.1[%] or lower [temperature 25 ±10°C]				
	Accel/Decel Time	Straight or S-curve acceleration/deceleration (0-10,000[ms], possible to be set by one[ms] unit)				
	Input Frequency	1[Mpps], line driver / 200[kpps], open collector				
	Input Pulse Type	Symbol + Pulse series, CW+CCW, A/B Phase				
RS-422	Specification	ANSI/TIA/EIA-422 standard specifications				
	Protocol	MODBUS-RTU				
	Synchro Method	Asynchronous				
	Power Consumption	100[mA]				
	Transmission Speed	9,600/19,200/38,400/57,600bps				
	Distance	Maximum 200[m]				
	Terminating Resistance	Connecting the outside connector (CN1 7Pin, 28Pin connection), Built-in 120Ω				
Digital Input / Output	Digital Input	Input voltage range : DC12V ~ DC24V Total 10 input channels (allocable) Total 34 function's input can be used selectively for assignment. (*SV_ON, *SPD/LVSF1, *SPD2/LVSF2, *SPD3, *A-RST, *JDIR, *POT, *NOT, *EMG, *STOP, START, REGT, HOME, HSTART, ISEL0, ISEL1, ISEL2, ISEL3, ISEL4, ISEL5, PCON, GAIN2, P_CL, N_CL, MODE, PAUSE, ABSRQ, JSTART, PCLR, AOVR, INHIBIT, EGEAR1, EGEAR2, ABS_RESET) * Basic allocation signal				
	Digital Output	Service rating : DC24V ±10%, 120mA 5 of 8 input channels are allocable, 3 channels are fixed with AL00, AL01, AL02 Total 19 function's input can be used selectively for assignment. (*ALARM, *READY, *ZSPD, *BREAK, *INPOS1, ORG, EOS, TGON, TLMT, VLMT, INSPD, WARN, INPOS2, IOUT0, IOUT1, IOUT2, IOUT3, IOUT4, IOUT5) * Basic allocation signal				
Analog Output		2 Channel Analog speed input (Command/Override) ±10V Analog torque input (Command/Limit) ±10V				
USB Communication	Connect	PC				
	Communication Standard	USB 2.0 full speed (Applies standard)				
	Specification	PC, USB 2.0 Full Speed (Applies standard)				
Internal Function	Dynamic Braking	Standard built-in brake (Activated when the servo alarm goes off or when the servo is off),				
	Regenerative Braking	Both default built-in and external installation possible				
	Display Function	7 segments (5DIGIT)				
	Additional Function	Gain tuning, alarm history, JOG operation, origin search				
	Protection Function	Excessive current/voltage/overload/overheating/speed, excessive current limit, low voltage, encoder/position following/current sensing fail				
Operation Environment	Operating Temperature / Storage Temperature	0~50°C / -20 ~ 65°C				
	Operating Humidity / Storage Humidity	Below80[%]RH / Below 90[%]RH(Avoid dew-condensation)				
	Environment	Indoor, avoid corrosive, inflammable gas or liquid, and electrically conductive dust.				

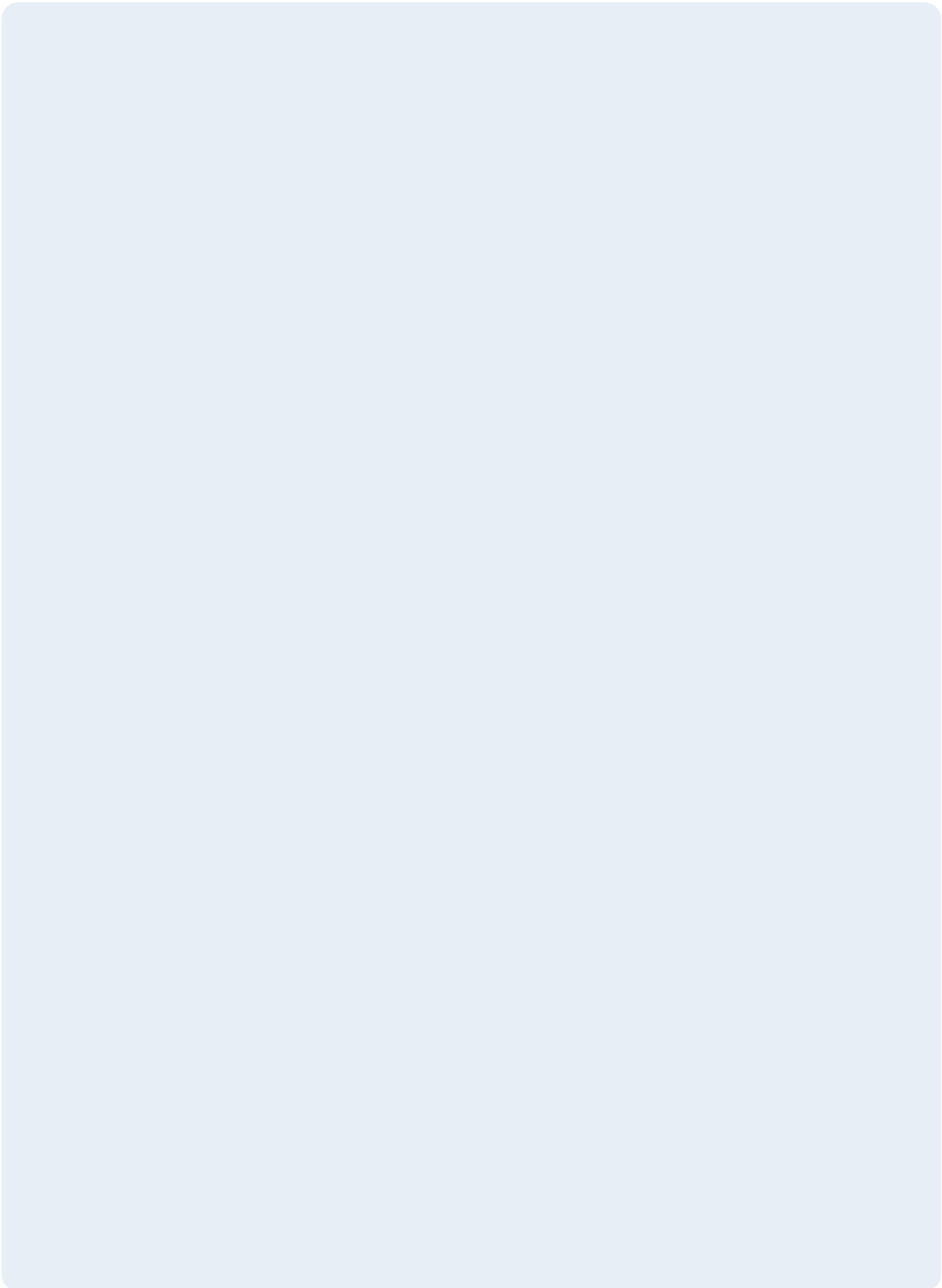

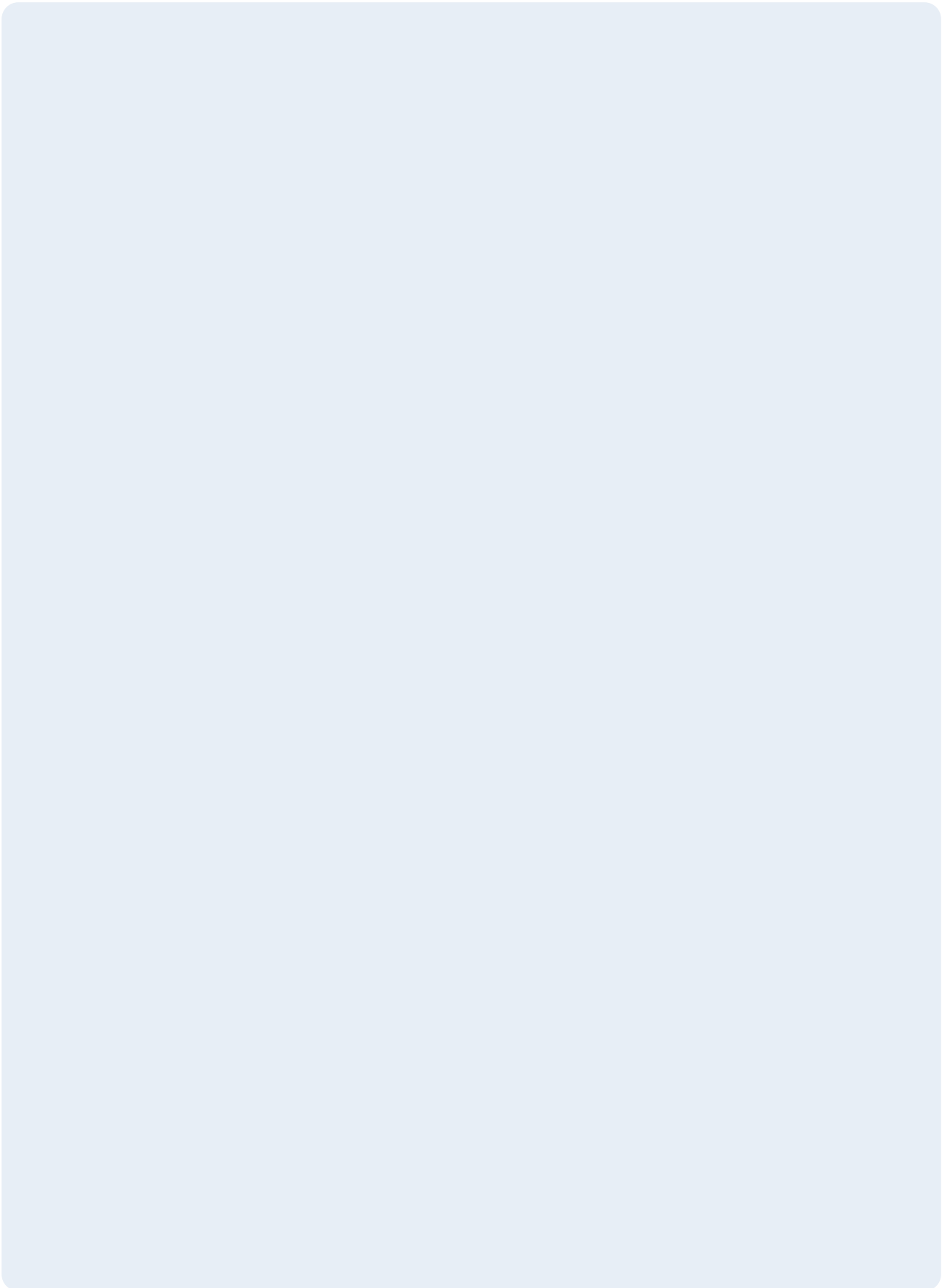



Safety Instructions

- For your safety, please read user's manual thoroughly before operating.
- Contact the nearest authorized service facility for examination, repair, or adjustment.
- Please contact qualified service technician when you need maintenance. Do not disassemble or repair by yourself!
- Any maintenance and inspection shall be performed by the personnel having expertise concerned.



- According to The WEEE Directive, please do not discard the device with your household waste.



www.ls-electric.com

■ **Headquarter**

LS-ro 127(Hogye-dong) Dongan-gu, Anyang-si, Gyeonggi-Do, 14119, Korea

■ **Seoul Office**

LS Yongsan Tower, 92, Hangang-daero, Yongsan-gu, Seoul, 04386, Korea
 Tel: 82-2-2034-4033, 4888, 4703 Fax: 82-2-2034-4588
 E-mail: automation@ls-electric.com

■ **Overseas Subsidiaries**

- **LS ELECTRIC Japan Co., Ltd. (Tokyo, Japan)**
 Tel: 81-3-6268-8241 E-Mail: japan@ls-electric.com
- **LS ELECTRIC (Dalian) Co., Ltd. (Dalian, China)**
 Tel: 86-411-8730-6495 E-Mail: china.dalian@lselectric.com.cn
- **LS ELECTRIC (Wuxi) Co., Ltd. (Wuxi, China)**
 Tel: 86-510-6851-6666 E-Mail: china.wuxi@lselectric.com.cn
- **LS ELECTRIC Middle East FZE (Dubai, U.A.E.)**
 Tel: 971-4-886-5360 E-Mail: middleeast@ls-electric.com
- **LS ELECTRIC Europe B.V. (Hoofddorp, Netherlands)**
 Tel: 31-20-654-1424 E-Mail: europartner@ls-electric.com
- **LS ELECTRIC America Inc. (Chicago, USA)**
 Tel: 1-800-891-2941 E-Mail: sales.us@lselectricamerica.com
- **LS ELECTRIC Turkey Co., Ltd.**
 Tel: 90-212-806-1225 E-Mail: turkey@ls-electric.com

■ **Overseas Branches**

- **LS ELECTRIC Tokyo Office (Japan)**
 Tel: 81-3-6268-8241 E-Mail: tokyo@ls-electric.com
- **LS ELECTRIC Beijing Office (China)**
 Tel: 86-10-5095-1631 E-Mail: china.auto@lselectric.com.cn
- **LS ELECTRIC Shanghai Office (China)**
 Tel: 86-21-5237-9977 E-Mail: china.auto@lselectric.com.cn
- **LS ELECTRIC Guangzhou Office (China)**
 Tel: 86-20-3818-2883 E-Mail: china.auto@lselectric.com.cn
- **LS ELECTRIC Chengdu Office (China)**
 Tel: 86-28-8670-3201 E-Mail: china.auto@lselectric.com.cn
- **LS ELECTRIC Qingdao Office (China)**
 Tel: 86-532-8501-2065 E-Mail: china.auto@lselectric.com.cn
- **LS ELECTRIC Nanjing Office (China)**
 Tel: 86-25-8467-0005 E-Mail: china.auto@lselectric.com.cn
- **LS ELECTRIC Bangkok Office (Thailand)**
 Tel: 66-90-950-9683 E-Mail: thailand@ls-electric.com
- **LS ELECTRIC Jakarta Office (Indonesia)**
 Tel: 62-21-2933-7614 E-Mail: indonesia@ls-electric.com
- **LS ELECTRIC Moscow Office (Russia)**
 Tel: 7-499-682-6130 E-Mail: info@lselectric-ru.com
- **LS ELECTRIC America Western Office (Irvine, USA)**
 Tel: 1-949-333-3140 E-Mail: america@ls-electric.com
- **LS ELECTRIC Italy office (Italy)**
 Tel: 39-030-8081-833 E-Mail: italia@ls-electric.com